



FUSION-F

User manual

Document Edition:

V1.0

The Manual for:

Fusion-F Camera

Date:

April 14, 2024

TABLE OF CONTENTS

SECTION 1	SYSTEM OVERVIEW	Page 3
SECTION 2	SYSTEM CONNECTION USER MANUAL	Page 6
SECTION 3	APPLICATION INSTALATION	Page 8
SECTION 4	APPLICATION OPERATION USER MANUAL	Page 11
SECTION 5	FUSION-F PRODUCT DATASHEET	Page 25

Notes:

For technical support please contact Ex-Sight.Com at info@ex-sight.com.

section 1

SYSTEM OVERVIEW

Default IP/Address Values

- User name: admin
- Password: 12345

Day IP Address: 192.168.1.160

Night IP Address: 192.168.1.161

SYSTEM MAIN PARTS

Front View



Rear View



Notes:

“Day Camera” mentioned in this manual refers to Low light sensor

“Night Camera” mentioned in this manual refers to the LWIR Thermal sensor

SC CABLE MAIN PARTS (Single Cable)

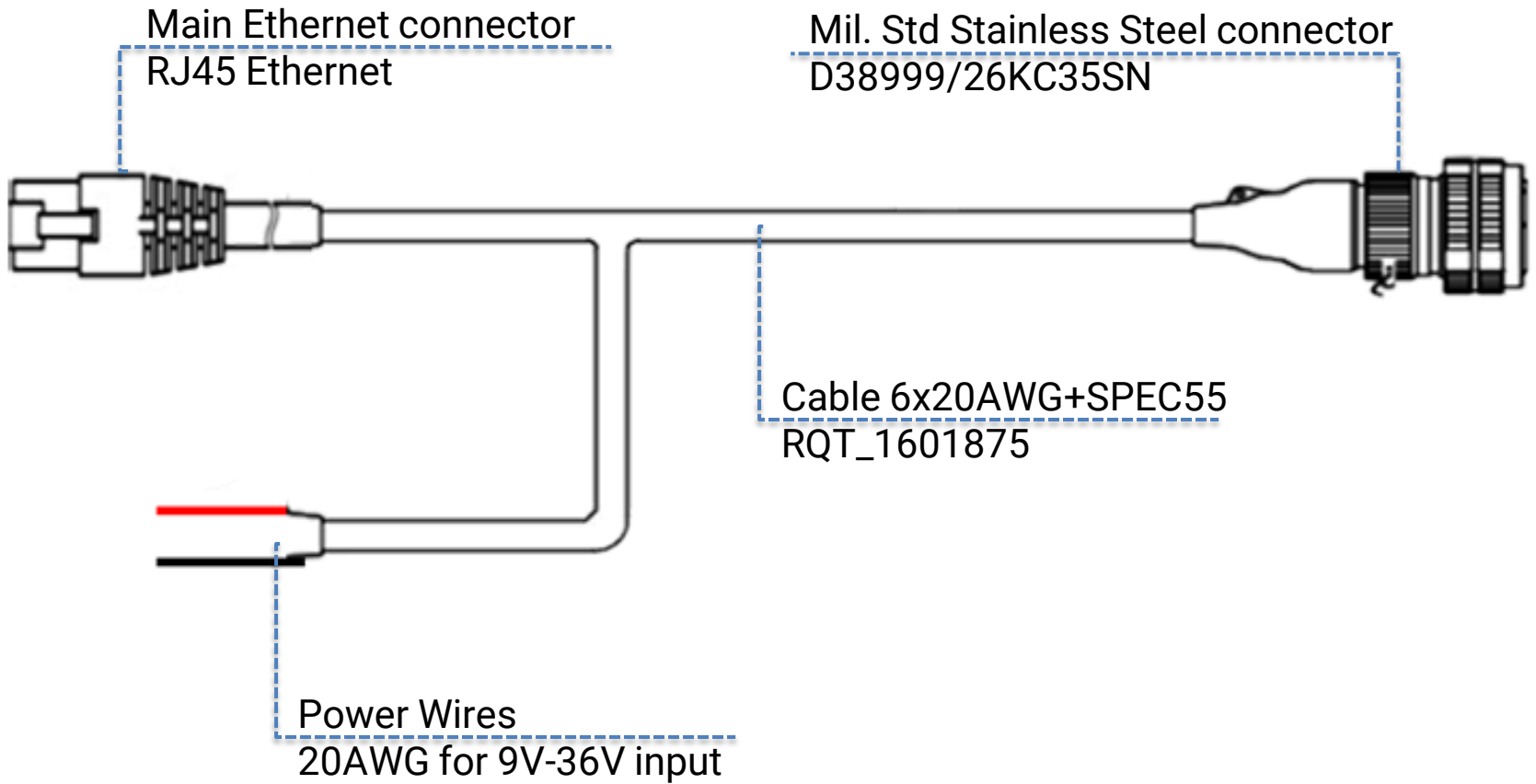

SS CABLE MAIN PARTS (Chain Cable)

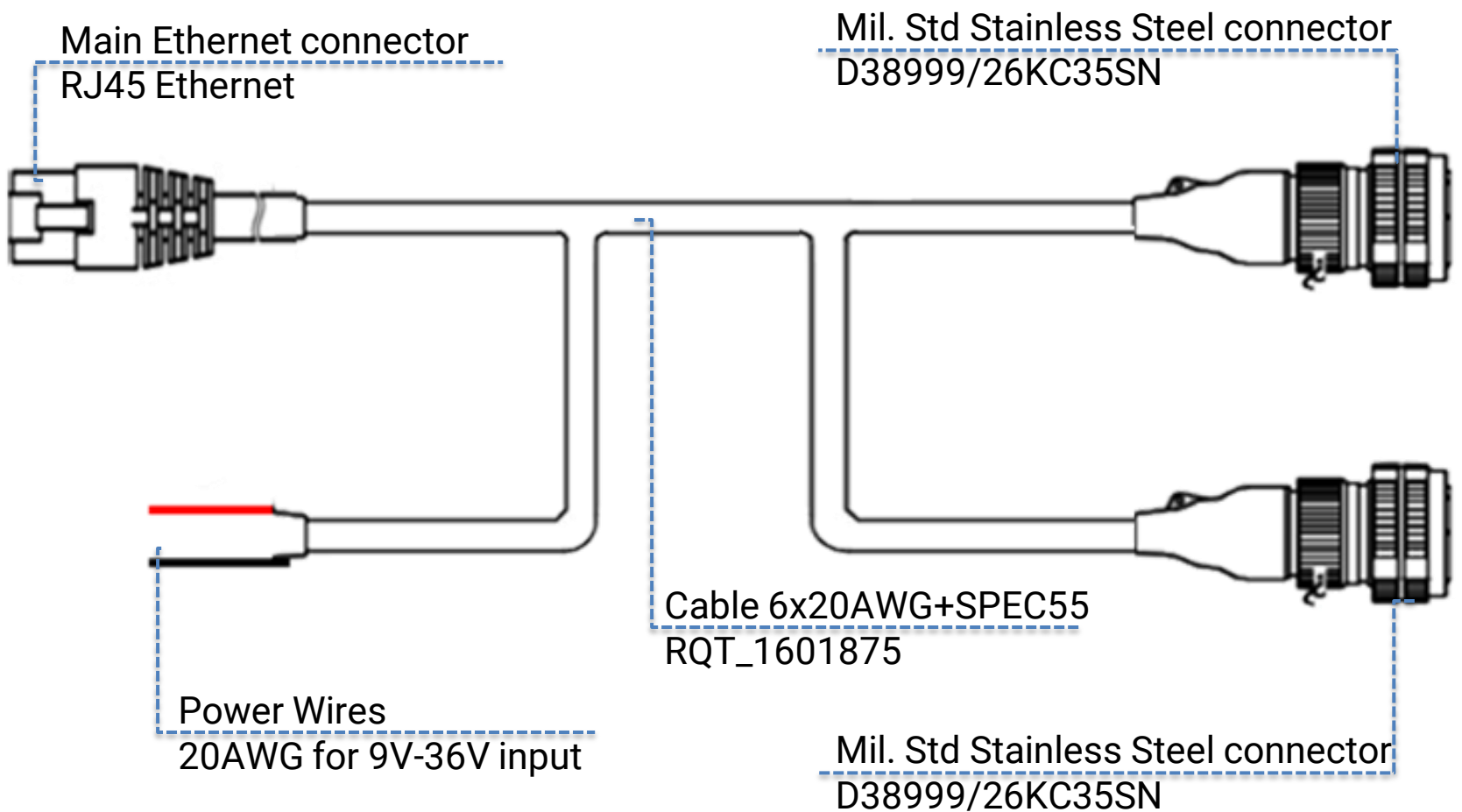

section 2

SYSTEM ASSEMBLY USER MANUAL

SYSTEM CONNECTION

Detailed description of system connection

STEP 1 Place the Fusion-F on a flat and stable surface.



STEP 2 Connect the **cable connector** (D38999/26KC35SN) on the Cable to the **panel connector** (D38999/23YC35PN) on the Fusion-F then screw the **cable connector** clockwise until it closes .

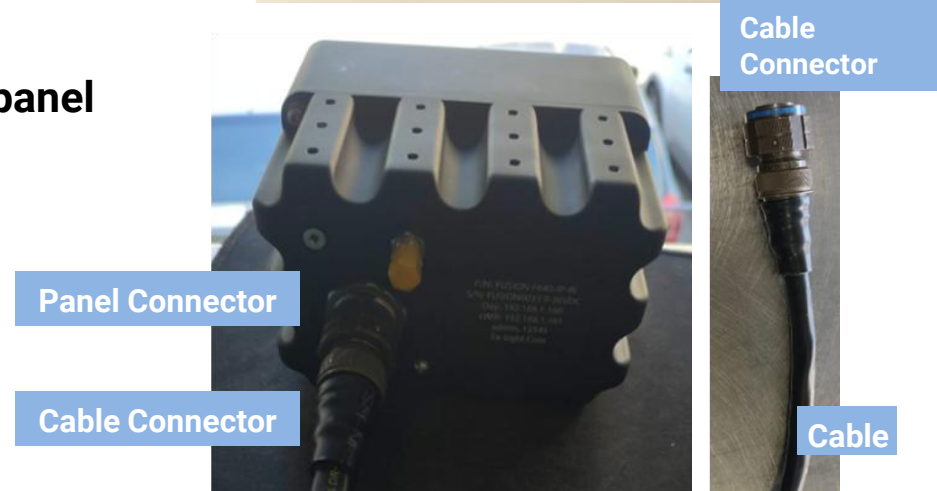

STEP 3 Connect the Ethernet connection on the Cable to the Ethernet port on the computer.

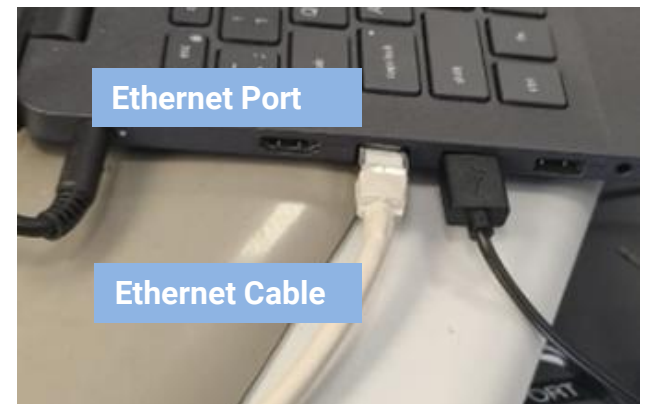

STEP 4 Connect the **Power Wires** on the Cable to the **Power Source**.
The supplied voltage should be 9V-36VDC (we recommend 12VDC).



section 3

APPLICATION INSTALATION

GETTING STARTED

Before using Fusion-F for the first time, download and install the **FusionDemo** application. Using this application allows easy control of the Fusion-F camera.

1. Go to Ex-Sight Website: <https://www.ex-sight.com/projects-6> (EOSS-FUSION-F) Double click on **CONTROL SOFTWARE** will start the app download process

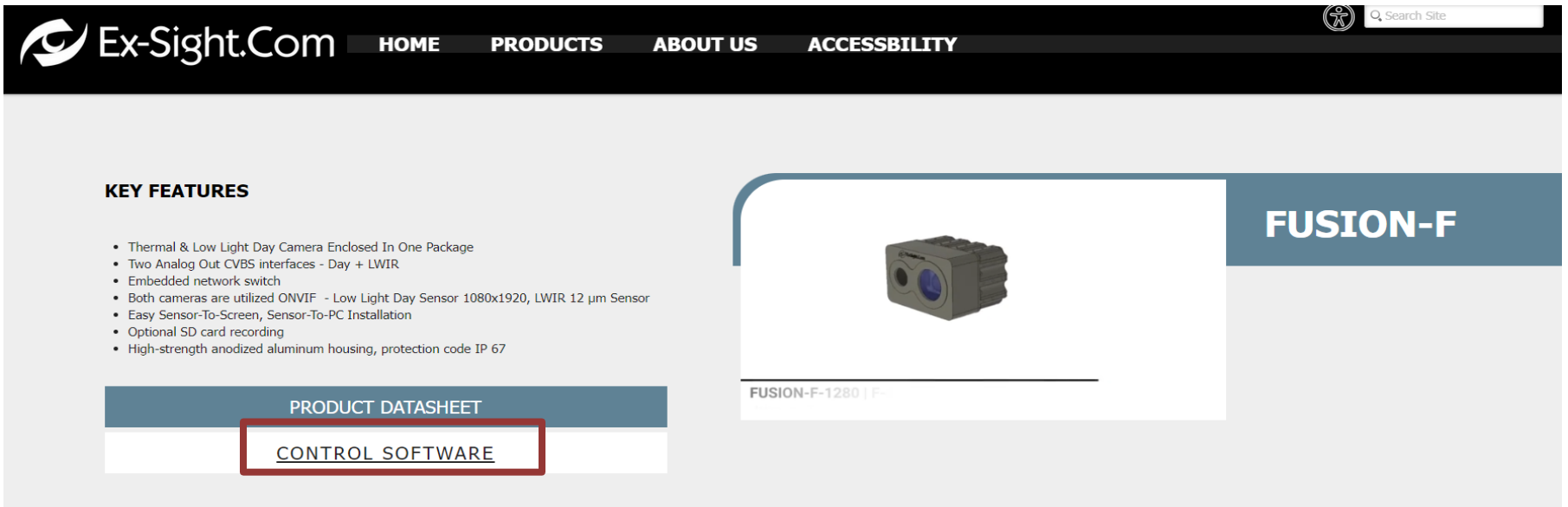

2. Once the file is downloaded (The **FusionSa Setup** file in ZIP mode), start the installation by running the downloaded file.

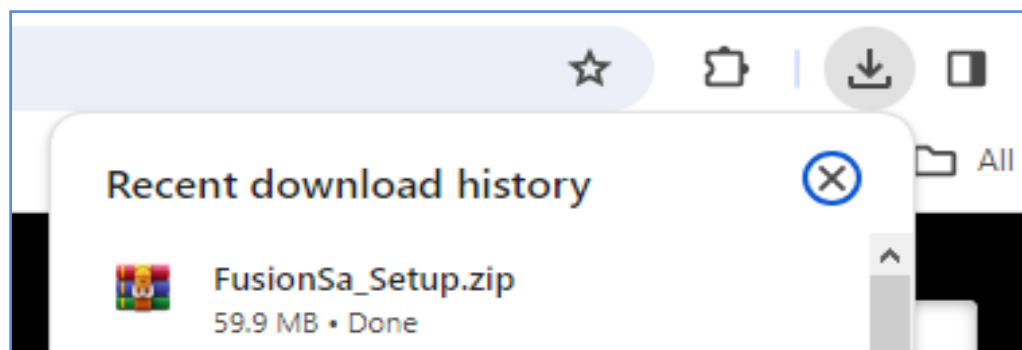

3. Extract ZIP **FusionSa Setup** file into a new folder.

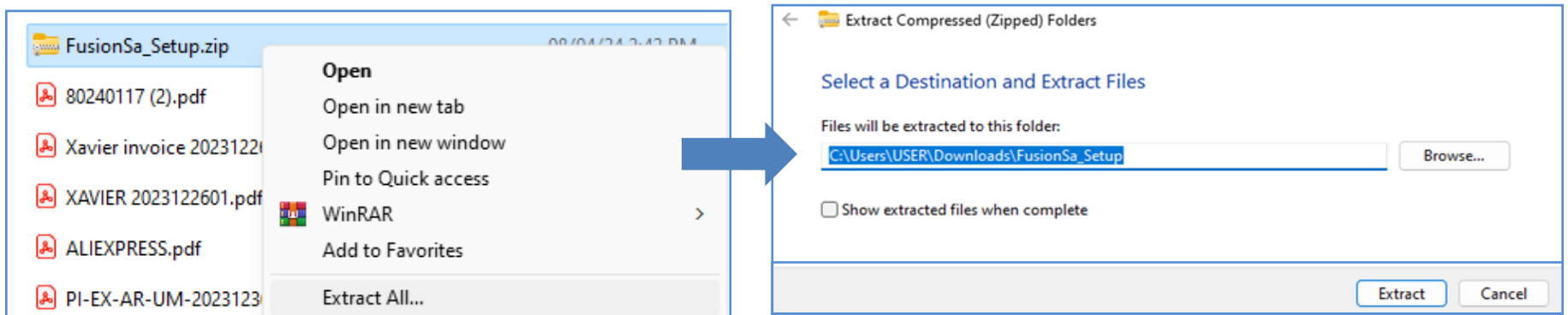

GETTING STARTED

Upon unzipping the **FusionSa Setup** file, the user needs to select the **Setup.exe** file to initiate the application installation process

1. Enter the **Setup.exe** File

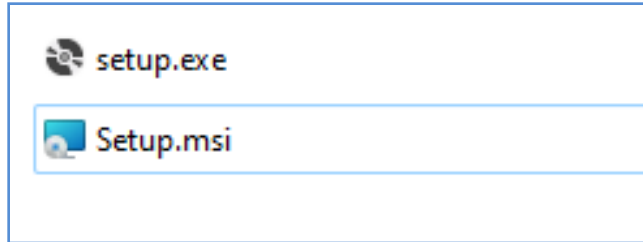

2. Enter the Setup Wizard, choose install path, then confirm the installation

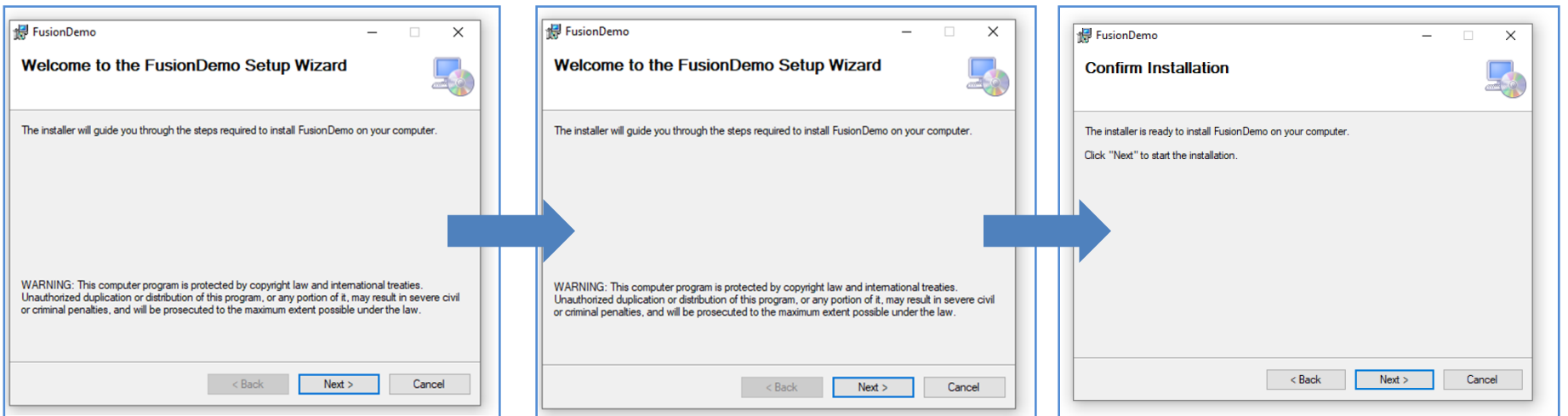

3. To start the installation, press the **[Install]**

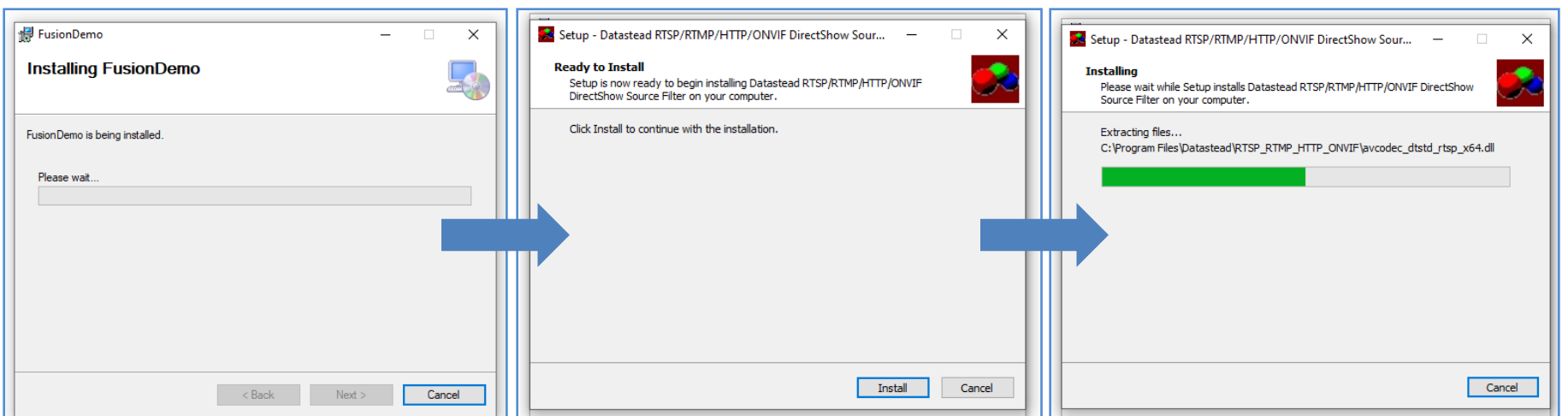

4. Click the **[Finish]** and then the **[Close]**.
Once complete, an app icon will appear on your desktop.

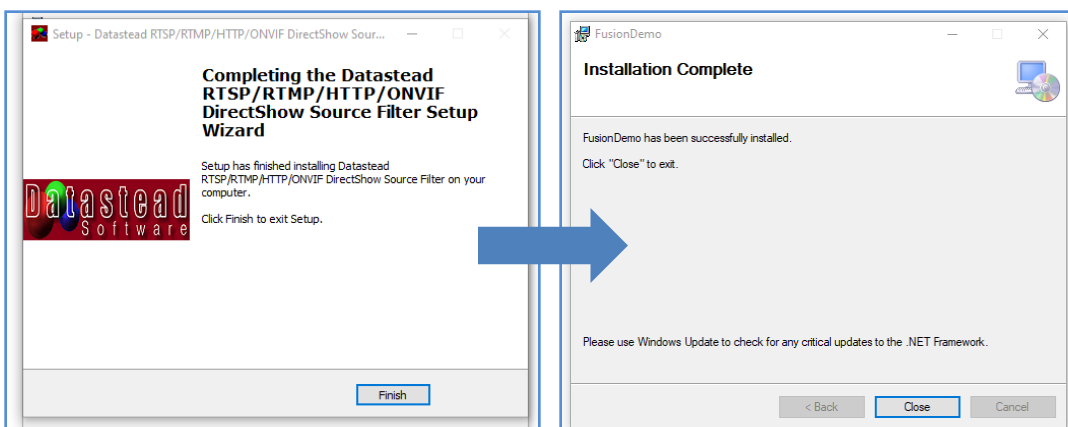

Section 4

APPLICATION OPERATION

APPLICATION OPERATION

Connect the Fusion-F camera before entering the application.

The video camera display application **FusionDemo** designed for both **Fusion-F** and **Situation Awareness** cameras developed by Ex-sight.com

After downloading the application, select the **Fusion-F** camera.

Application home screen:

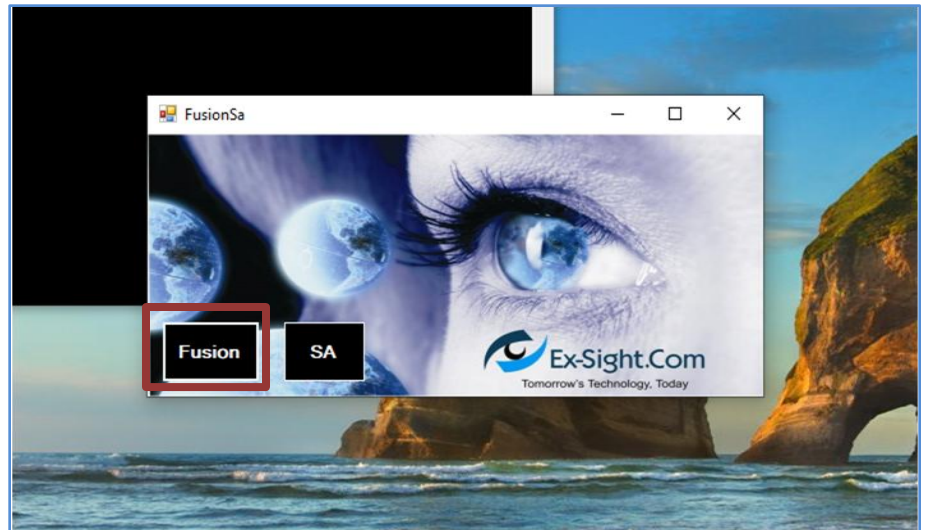

The initial screen of the APP: When Fusion-F is connected the stream from the cameras will appear on screen:

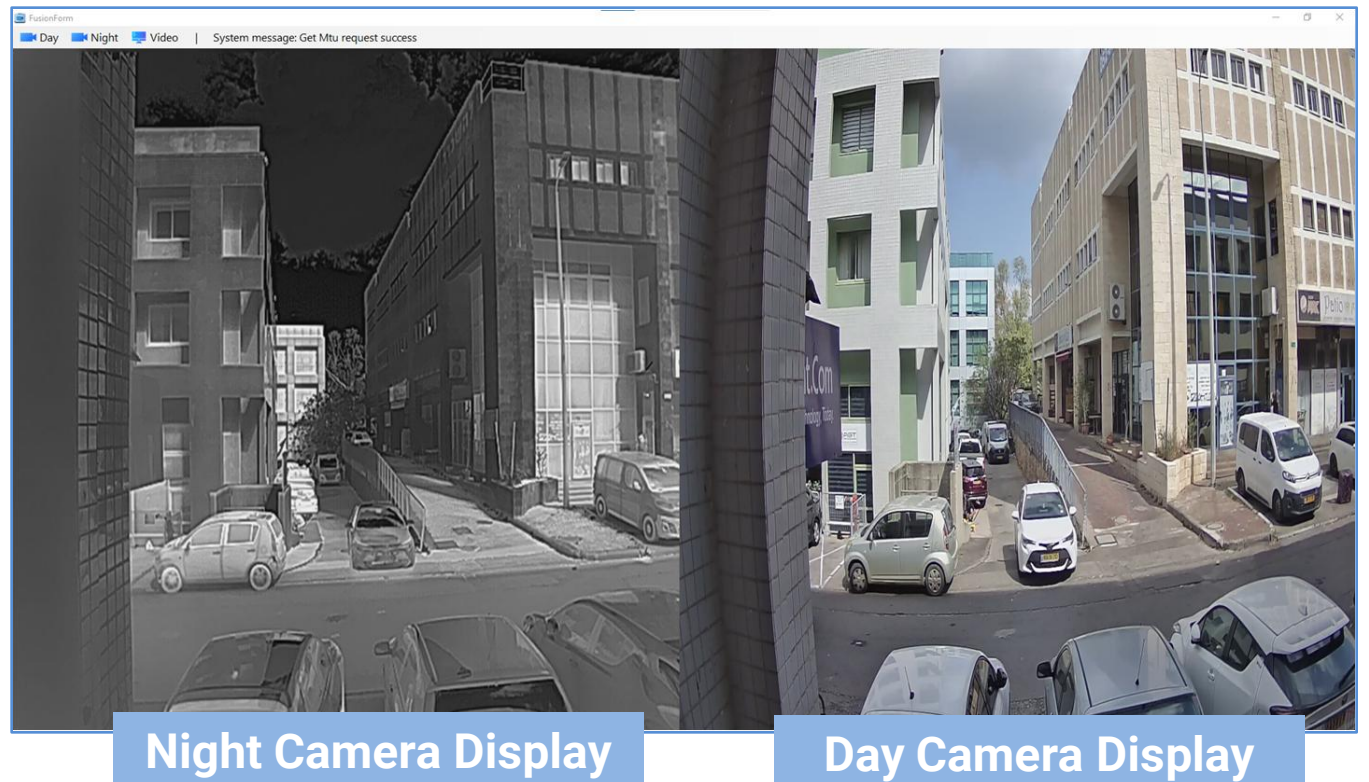

Main Menu Bar: the Toolbar on the main screen include DAY camera, NIGHT camera, VIDEO and SYSTEM MESSAGES

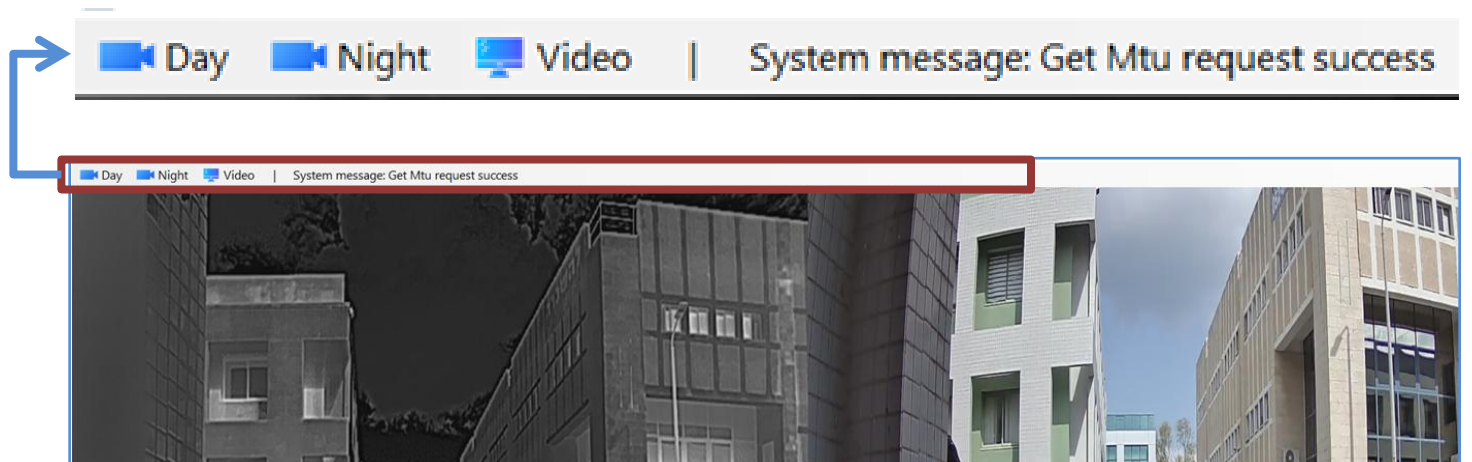

FUSION TOOLBAR OVERVIEW

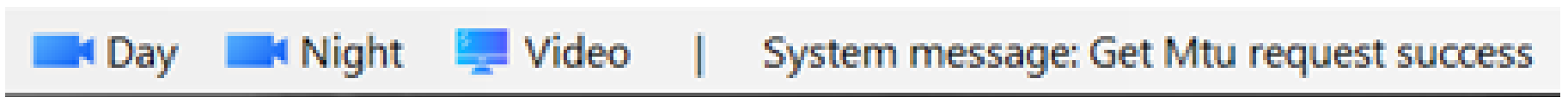

Camera Functionalities

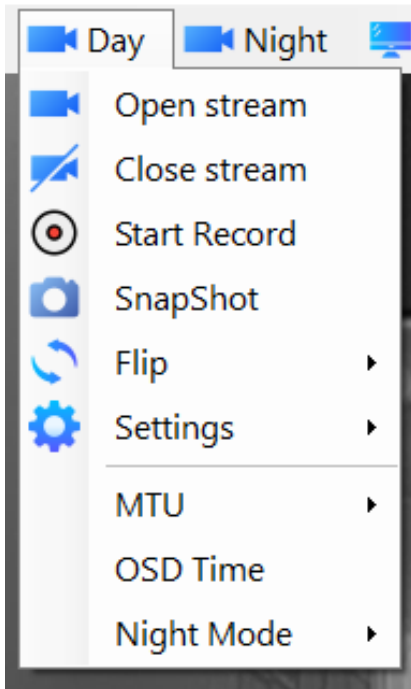

[Detailed Description Page 14-16](#)

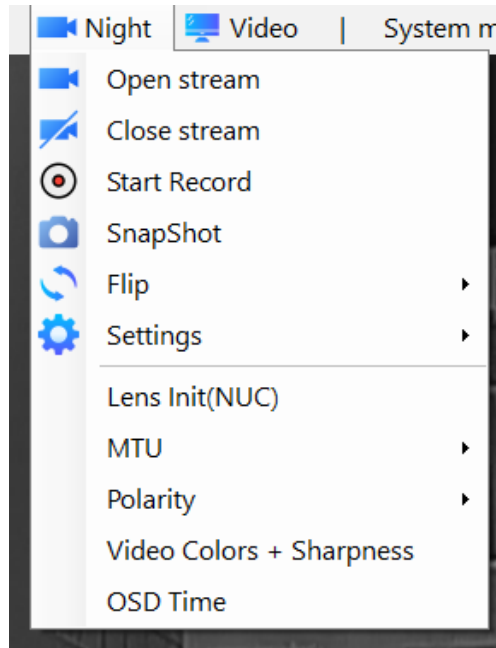

[Detailed Description Page 18](#)

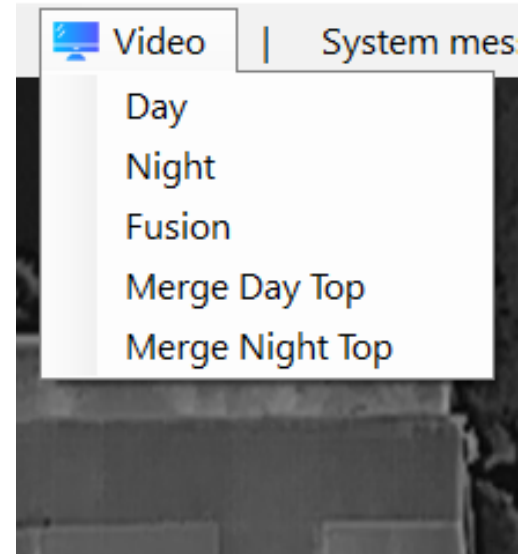

[Detailed Description Page 23](#)

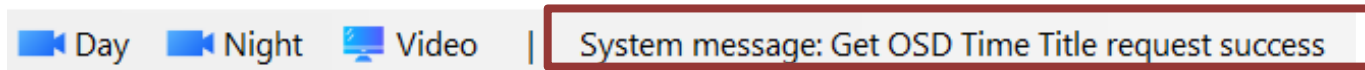

The System message is a line indicating whether the given system command was successful or not (relevant only to system command)

For Example: After press the OSD Time command the system will shown

System message: Get OSD Time Title request success

The **System commands** are at the bottom of the day camera and the night camera toolbar:

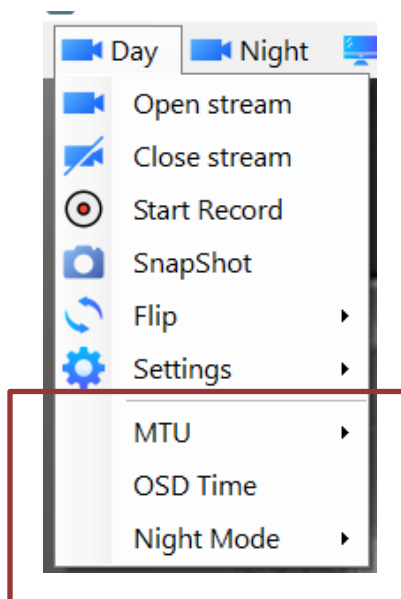



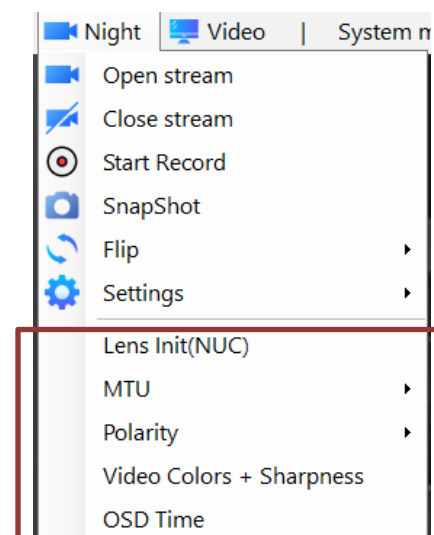





[Detailed Description Page 17](#)



[Detailed Description Page 21-22](#)

TOOLBAR INDEX. DAY CAMERA

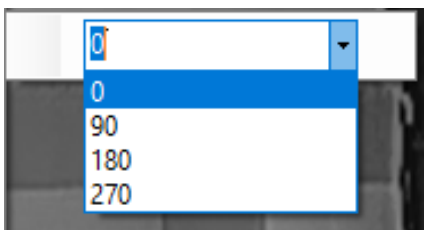
Detailed overview of the **DAY CAMERA** functions

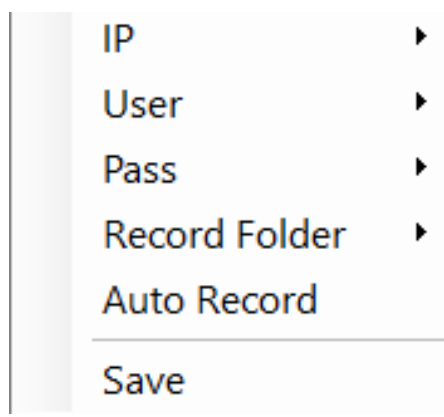
 Open stream	<p>The Day camera video stream connect automatically and the video from the Day camera will appear on the application screen. By clicking on Open stream it will connect the day camera video stream. This action is also valid in case the Day camera disconnects and does not connect automatically after disconnection, or if the Day camera video is turned off</p>	
 Close stream	<p>Clicking on Close stream will cause the application to turn off the video of the Day camera (not to disconnect the camera) and the video of the Day camera will be hidden. In order to turn the video back on, you need to click on the Open stream and the application will show the Day camera video stream on the application screen</p>	
 Start Record  Stop Record	<p>Clicking on Start Record will cause the application to start recording the video. When the application records the video, the icon changes to: Stop Record</p>	<p>Clicking on Stop Record will cause the application to end the recording and create and save a recording file in the folder where the installation files of the application are saved</p>
 Snapshot	<p>Clicking on Snapshot will cause the application to open the file folder for the operator to choose the location and name of the image file that the application create (JPG type file). After the selection and clicking save, the image file will be saved in the choosing location</p>	
 Flip <i>Example in the page 17</i>	<p>Flip will cause the application to rotate the video image received from the day camera according to the desired degrees. Clicking on Flip will open a selection line:</p> 	<p>In the selection bar, the operator can choose from the following options the number of degrees by which the application will rotate the video image from the day camera. The default is 0 degrees. The choices are: 90 degrees, 180 degrees and 270 degrees.</p>
 Settings <i>Detailed Description Page18</i>	<p>Settings shows the current settings of the Day camera and allows the operator to change the settings if necessary. Clicking on Settings will open another toolbar with the settings categories</p>	

FLIP EXAMPLE

0°

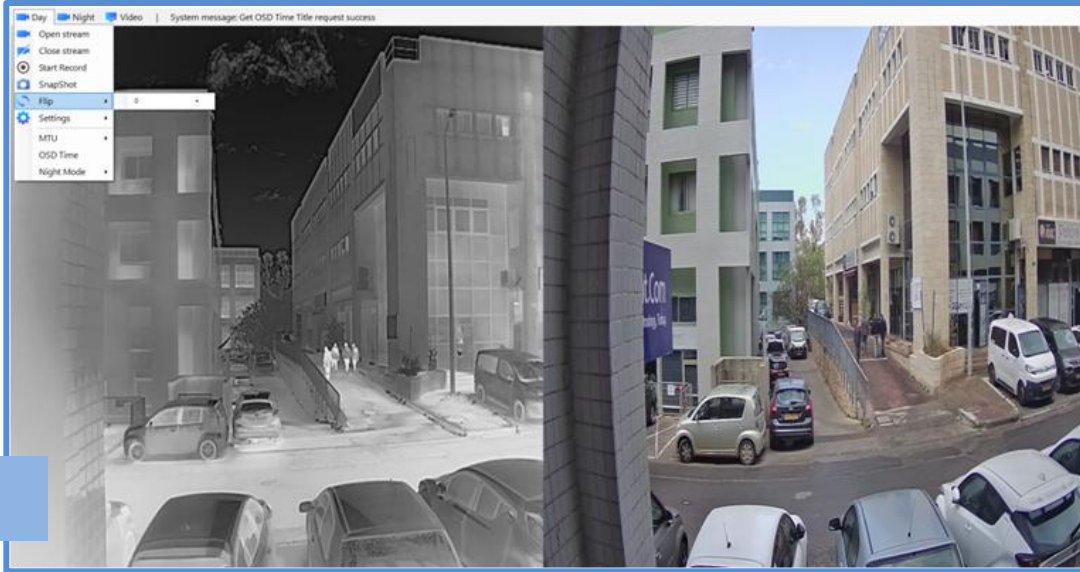

90°

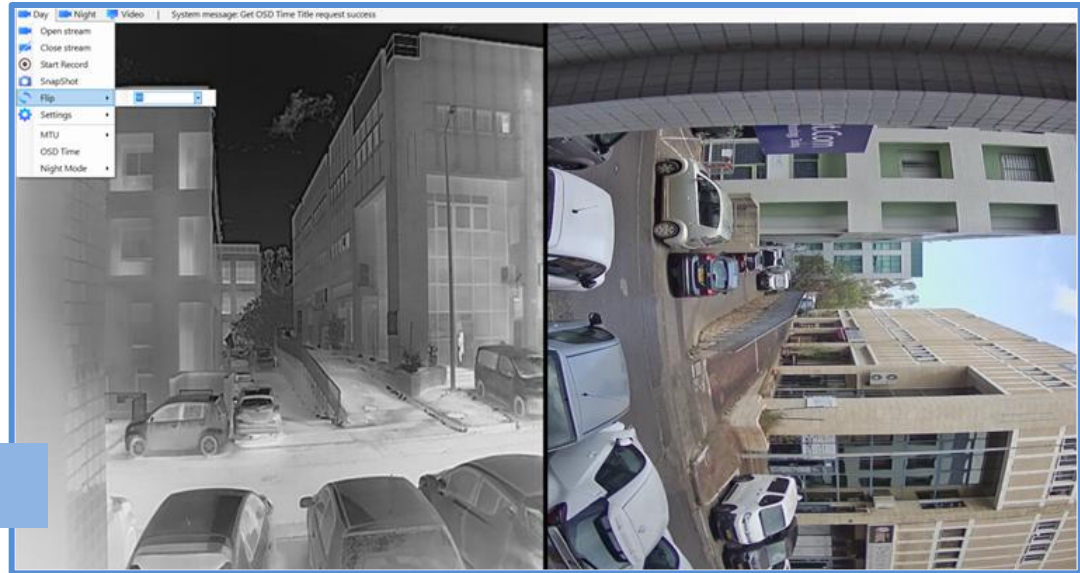

180°



270°

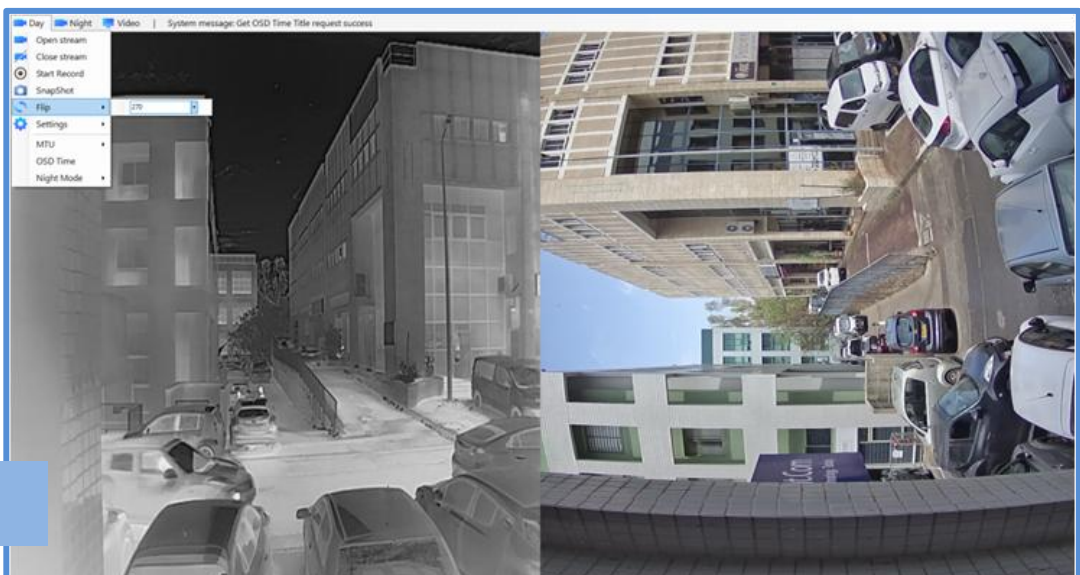

DAY CAMERA. SETTINGS

Detailed description of the contents of the **SETTINGS** tab

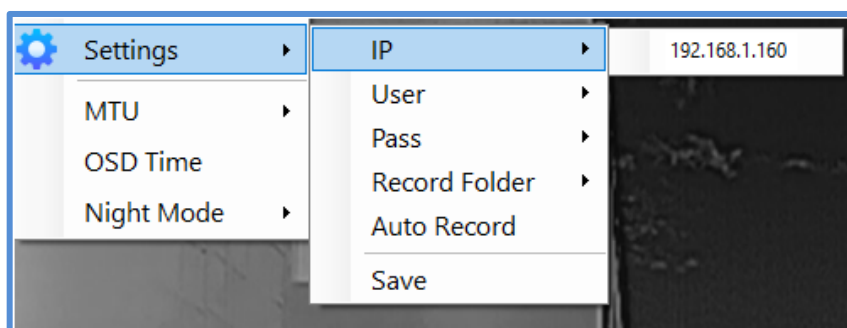

IP

The configured IP address of the Day camera.
Default: 192.168.1.160

The operator can changed it in the selection line

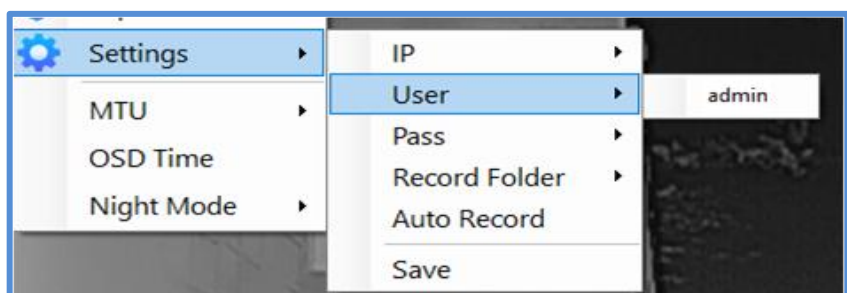

USER

The configured User name of the Day camera.
Default: admin

The operator can changed it in the selection line

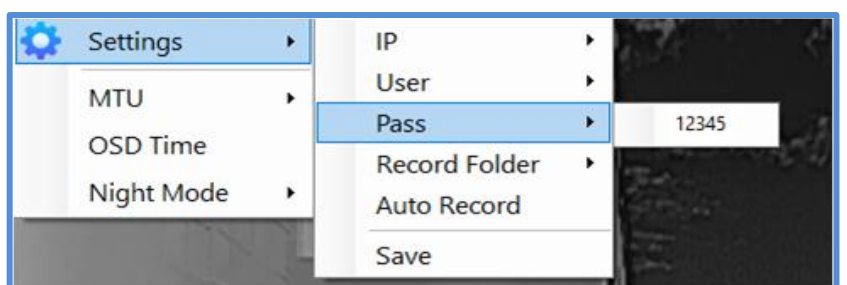

PASS

The configured Password of the Day camera.
Default: 12345

The operator can changed it in the selection line

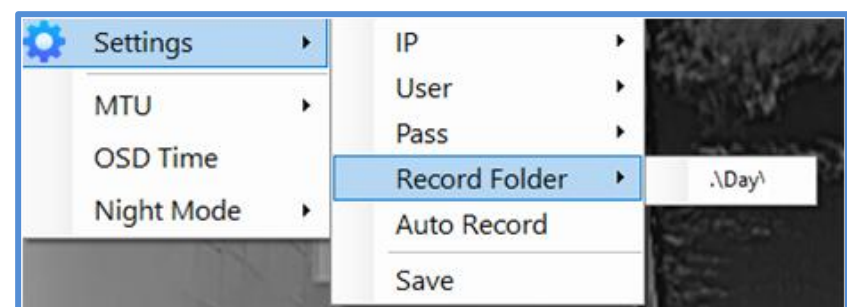

RECORD FOLDER

The configured Record Folder of the Day camera
Videos recording.

Default: .\day

The operator can changed it in the selection line

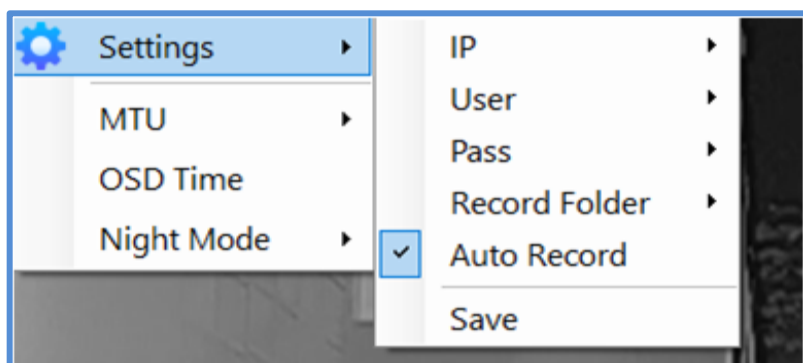

AUTO RECORD

The Auto Record of the Day camera.

Default: manual recording

The operator can changed it in to automatic
record: Auto Record

The application will record automatically all the time

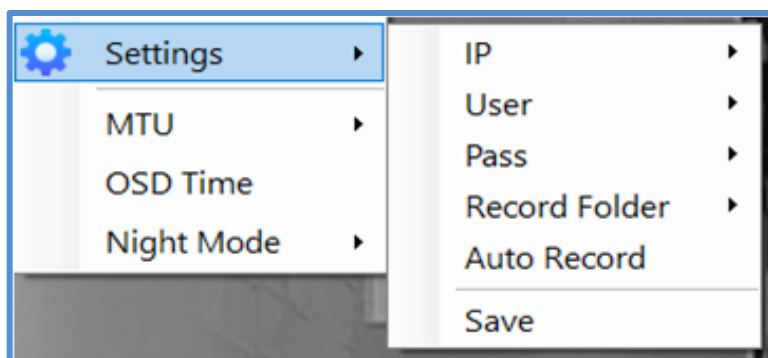

SAVE

Save is for saving changing on the setting.

Clicking on Save will cause the application to save
the operator changes off the setting.

DAY CAMERA. SYSTEM COMMANDS

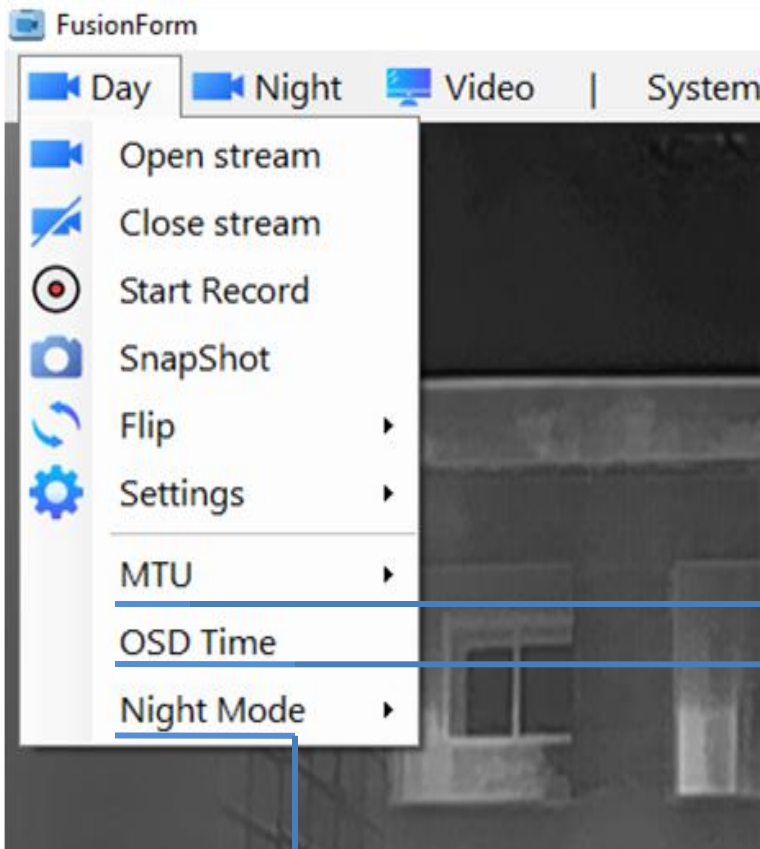

MTU

Traffic speed Determining: the traffic speed of the Day camera video stream.

Clicking on MTU opens another toolbar:

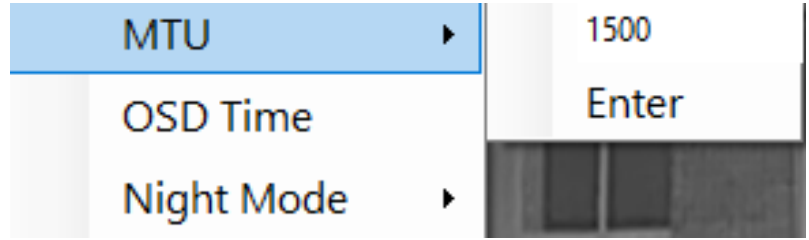

In the first row the operator can change the speed and click on Enter to save the new speed.

OSD Time

Clicking on OSD Time will cause the date and time to appear on the Day camera video image.

When the date and time is shown on the video image the OSD Time will shown:

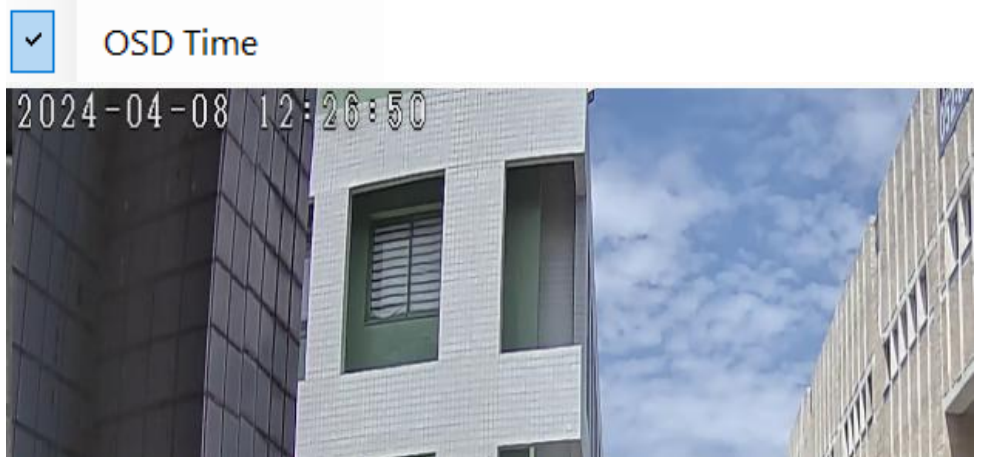

Night Mode

Night Mode will cause the Day camera video image to turn colures to black white colures. Clicking on Night Mode opens another toolbar:

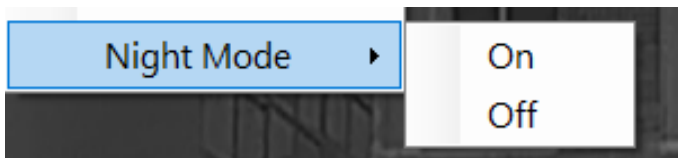









On: turns the Night Mode on - Day camera video image colures is black white colures.

Off: turns the Night Mode off- Day camera video image colures is multicolored.

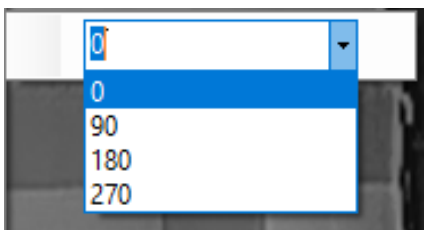

TOOLBAR INDEX. NIGHT CAMERA

Detailed overview of the Night **CAMERA** functions

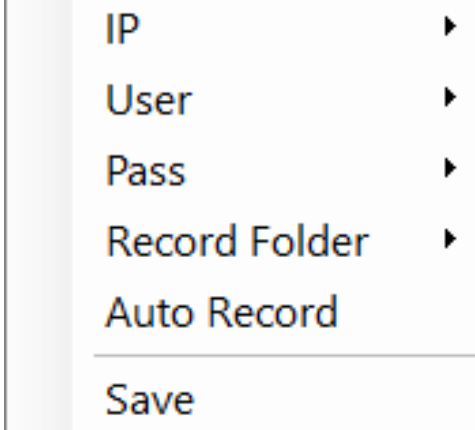
 Open stream	<p>The Night camera video stream connect automatically and the video from the Night camera will appear on the application screen. If not, clicking on Open stream will connect the Night camera video stream. This action is also valid in case the Night camera disconnects and does not connect automatically after disconnection, or if the Night camera video is turn off</p>	
 Close stream	<p>Clicking on Close stream will cause the application to turn off the video of the Night camera (not to disconnect the camera) and on the video of the Night camera will not appear on the application. In order to turn the video back on, you have to click on the Open stream and the application will tern on the Night camera video stream on the application screen.</p>	
 Start Record  Stop Record	<p>Clicking on Start Record will cause the application to start recording the video. When the application records the video, the icon changes to: Stop Record</p>	<p>Clicking on Stop Record will cause the application to end the recording and create and save a recording file in the folder where the installation files of the application are saved</p>
 SnapShot	<p>Clicking on Snapshot will cause the application to open the file folder for the operator to choose the location and name of the image file that the application create (JPG type file). After the selection and clicking save, the image file will be saved in the choosing location</p>	
 Flip <i>Example in the page 21</i>	<p>Flip will cause the application to rotate the video image received from the day camera according to the desired degrees. Clicking on Flip will open a selection line:</p> 	<p>In the selection bar, the operator can choose from the following options the number of degrees by which the application will rotate the video image from the day camera. The default is 0 degrees. The choices are: 90 degrees, 180 degrees and 270 degrees.</p>
 Settings <i>Detailed Description Page22</i>	<p>Settings shows the current settings of the Night camera and allows the operator to change the settings if necessary. Clicking on Settings will open another toolbar with the settings categories</p>	

FLIP EXAMPLE

0°

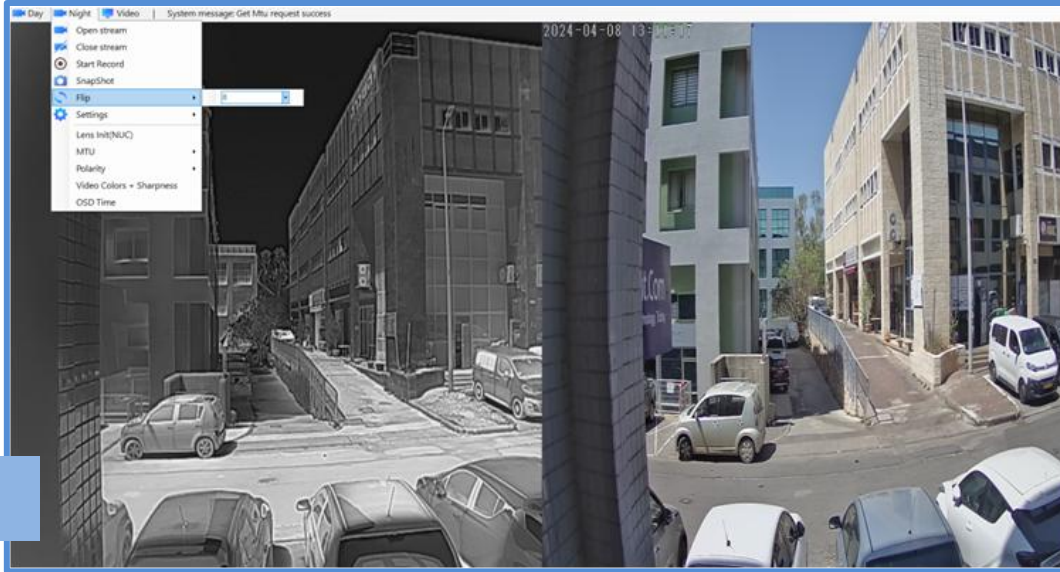

90°

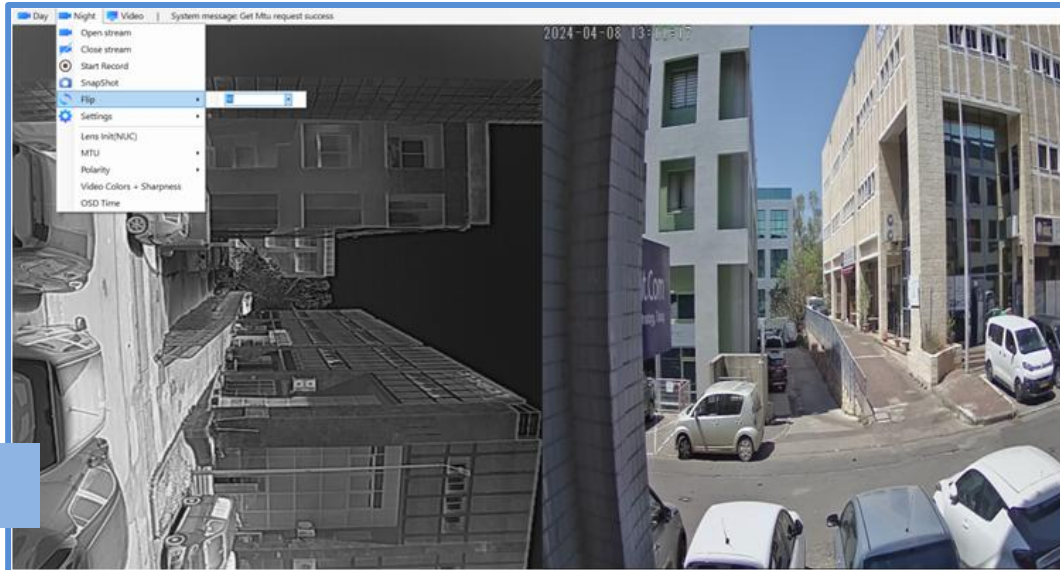

180°

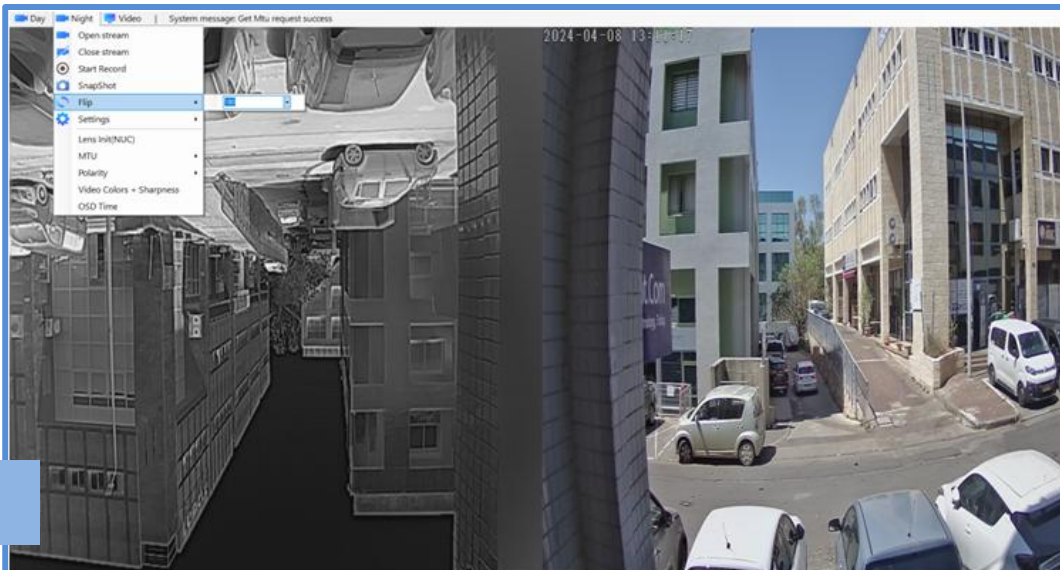

270°

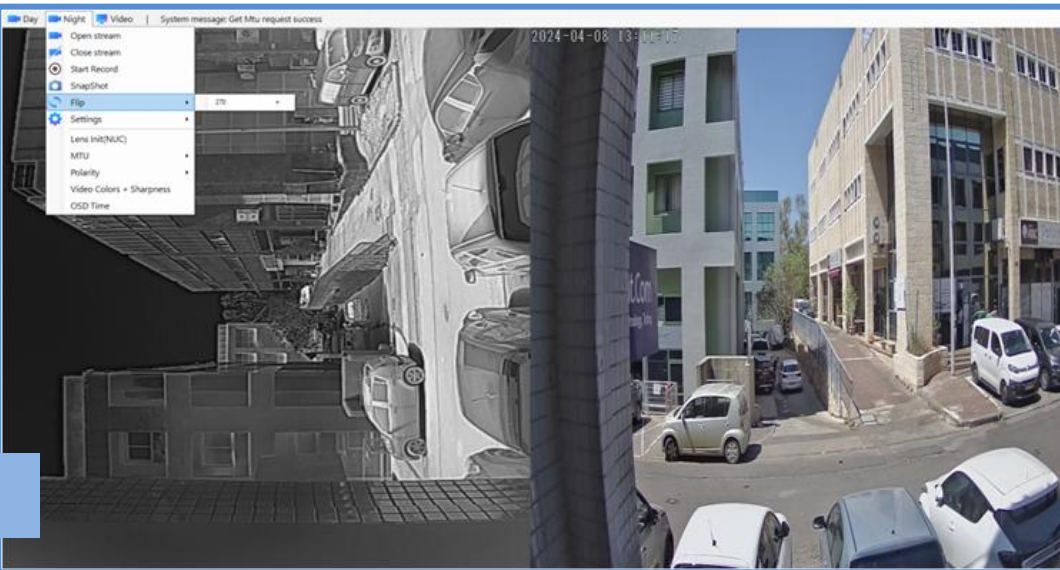

NIGHT CAMERA. SETTINGS

Detailed description of the contents of the **SETTINGS** tab

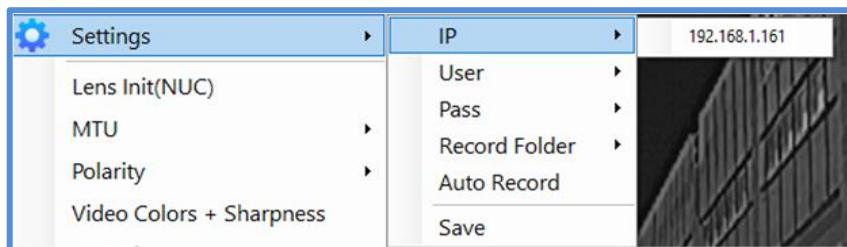

IP

The configured IP address of the Night camera.
Default: 192.168.1.161

The operator can change it in the selection line

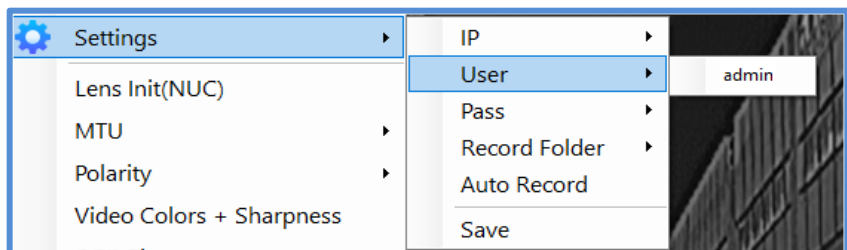

USER

The configured User name of the Night camera.
Default: admin

The operator can change it in the selection line

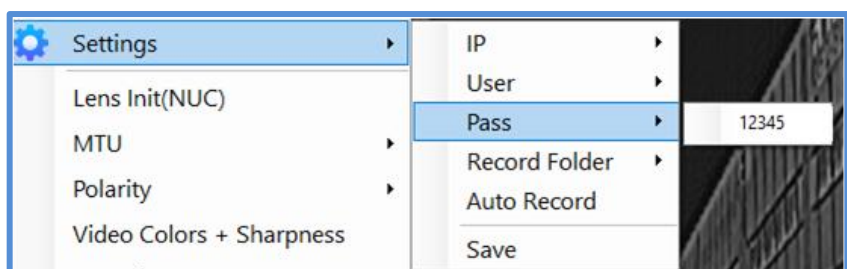

PASS

The configured Password of the Night camera.
Default: 12345

The operator can change it in the selection line

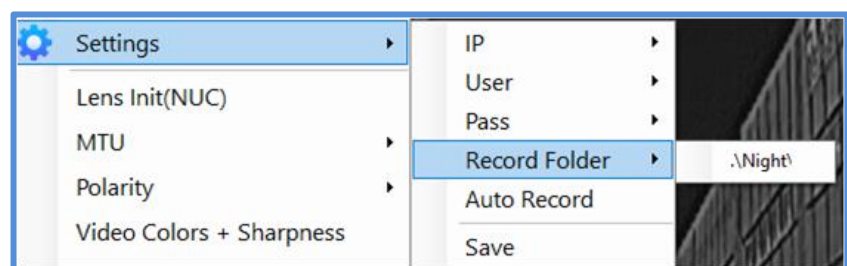

RECORD FOLDER

The configured Record Folder of the Night camera
Videos recording.

Default: .\night

The operator can change it in the selection line

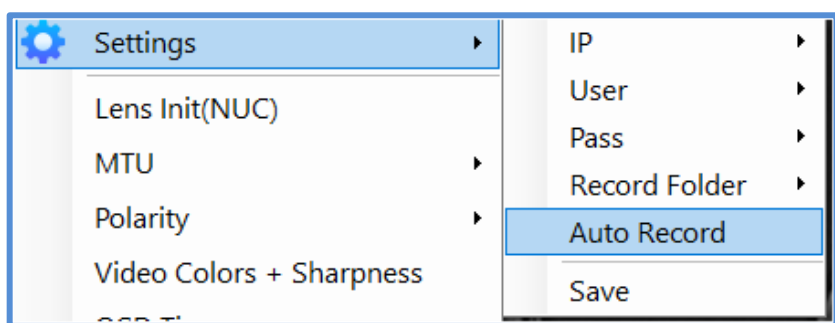

AUTO RECORD

The Auto Record of the Night camera.

Default: manual recording

The operator can change it in to automatic
record: Auto Record

The application will record automatically all the time

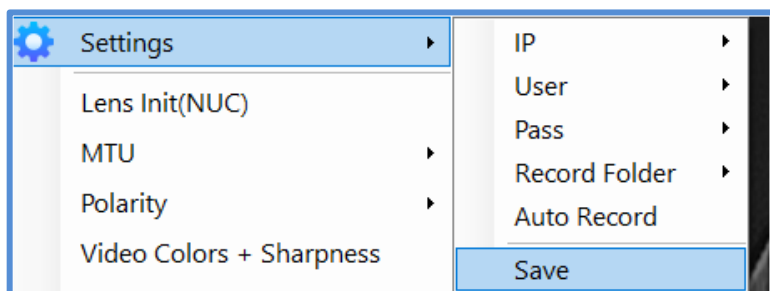

SAVE

Save is for saving changing on the setting.

Clicking on Save will cause the application to save
the operator changes off the setting.

NIGHT CAMERA. SYSTEM COMMANDS

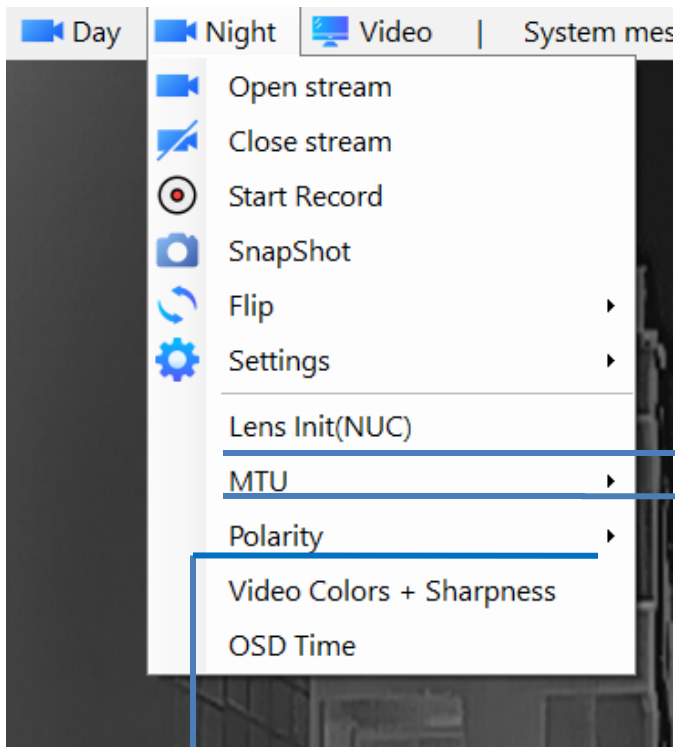

Lens Init(NUC)

Lens Init (NUC) enhances thermal image accuracy of the Night camera video stream. Clicking on NUC enhances thermal image accuracy and adjusting the image accordingly

MTU

Traffic speed Determining: the traffic speed of the Night camera video stream. Clicking on MTU opens another toolbar:

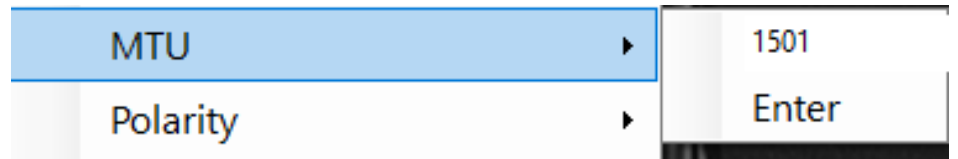

Polarity

Polarity will cause the application to change the polarization information of the Night camera. The default is White Hot. Clicking on Polarity will open a selection line:

In the first row the operator can change the speed and click on Enter to save the new speed.

Polarity examples:

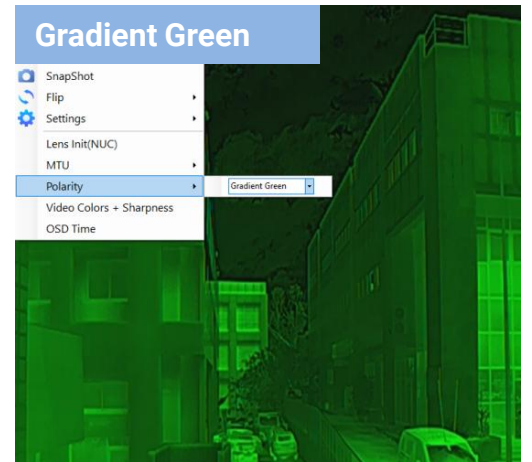
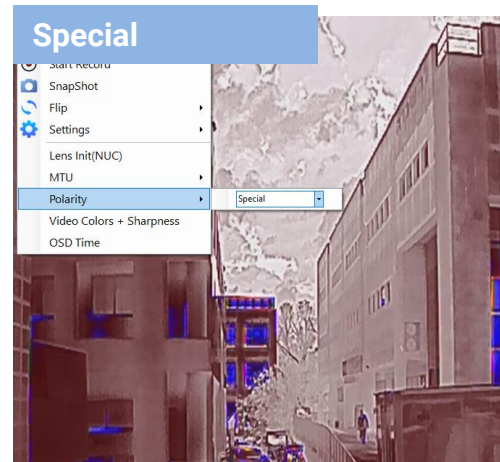
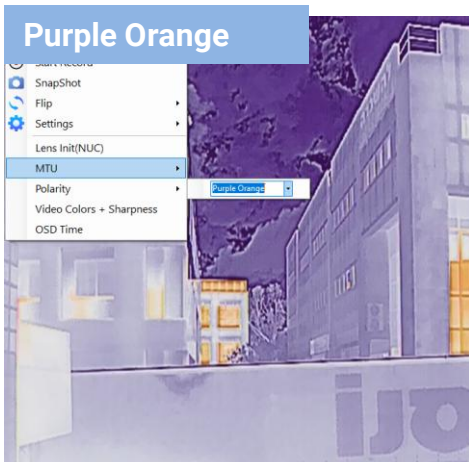
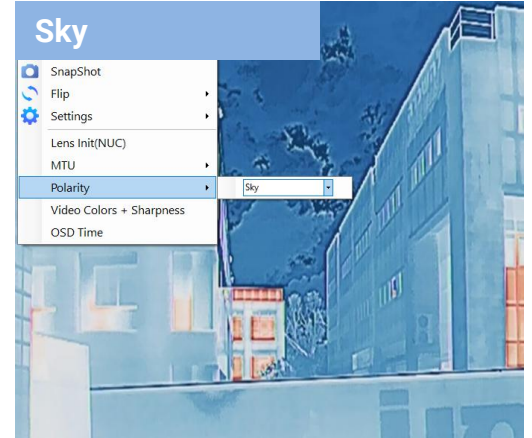
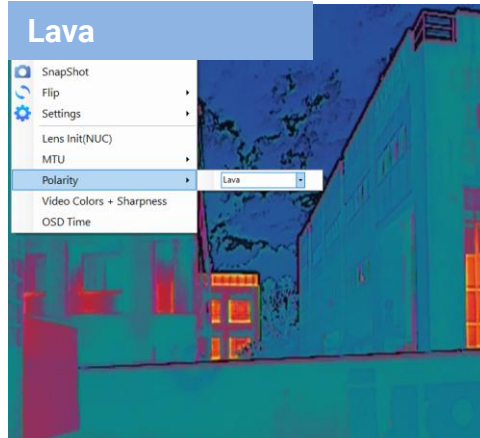
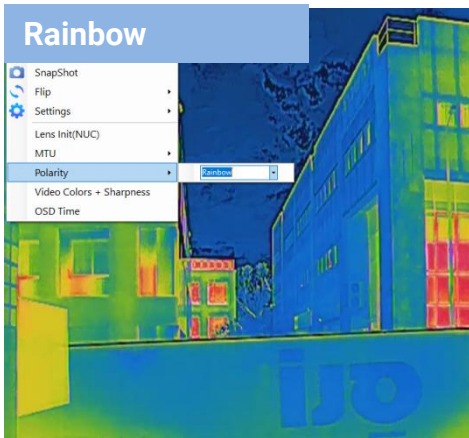

NIGHT CAMERA. SYSTEM COMMANDS

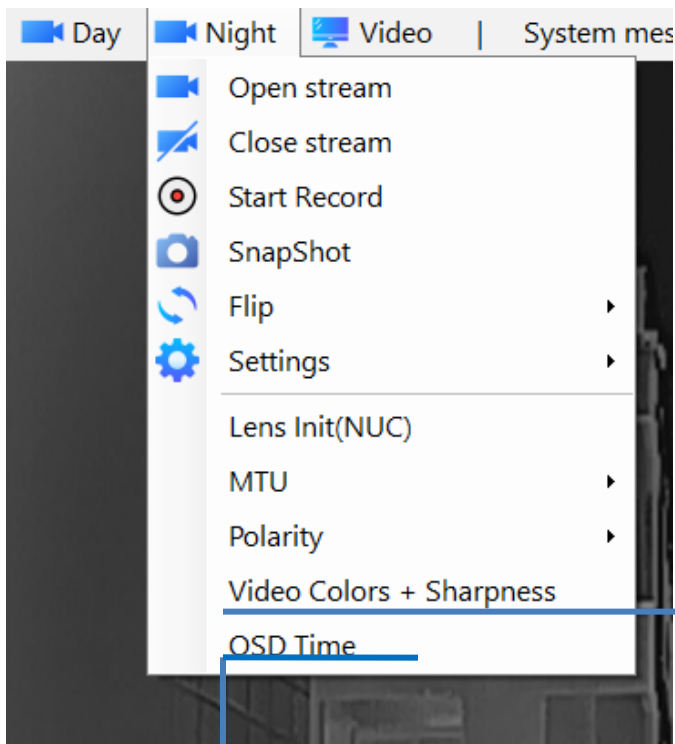

Video Colors + Sharpness

Video Colors + Sharpness allow the operator to adjust the Night camera settings. Clicking on Video Colors + Sharpness will open the toolbar: Night camera settings:

Night camera settings:

Clicking on Video Colors + Sharpness will open the toolbar: Night camera settings:

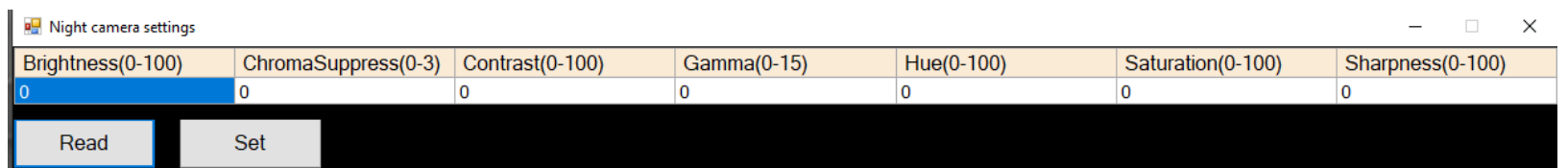

Clicking on Read will update the data on the toolbar to the Current data

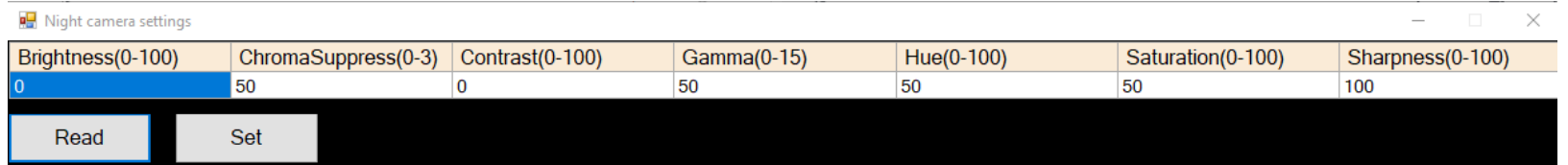

In order to change the setting, the operator double click on the line and then enter the desired data and then click on set to save the new setting.

Example:

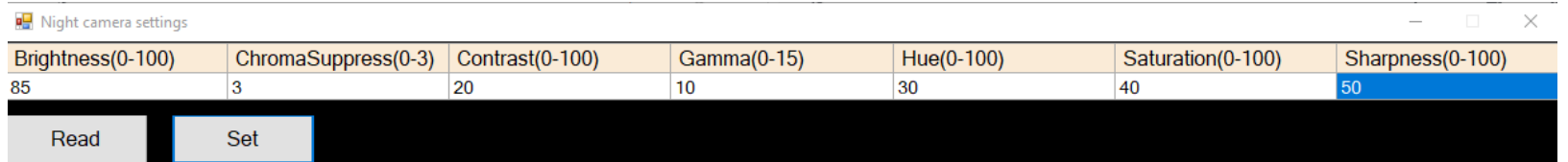

OSD Time

Clicking on OSD Time will cause the date and time to appear on the Night camera video image.

When the date and time is shown on the video image the OSD Time will shown:

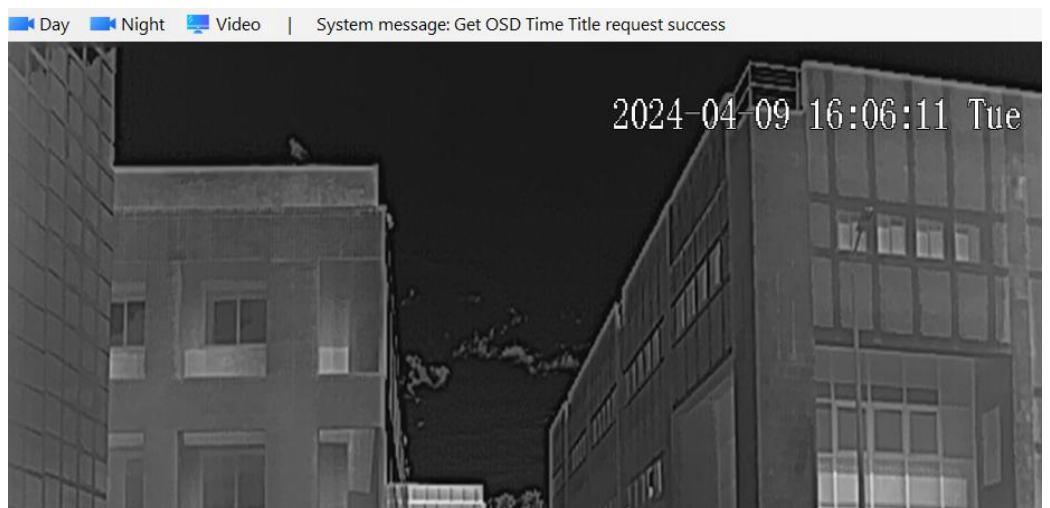
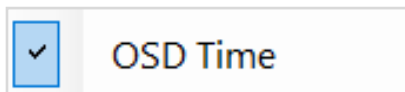

TOOLBAR INDEX. VIDEO

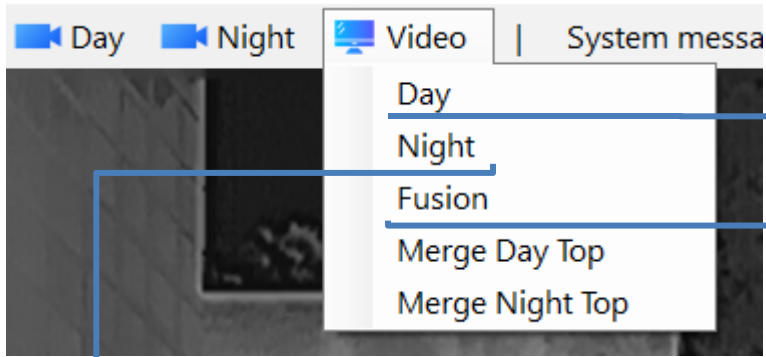

Day

Clicking on Day will cause the application to show only the stream from the day camera on the whole screen: Day

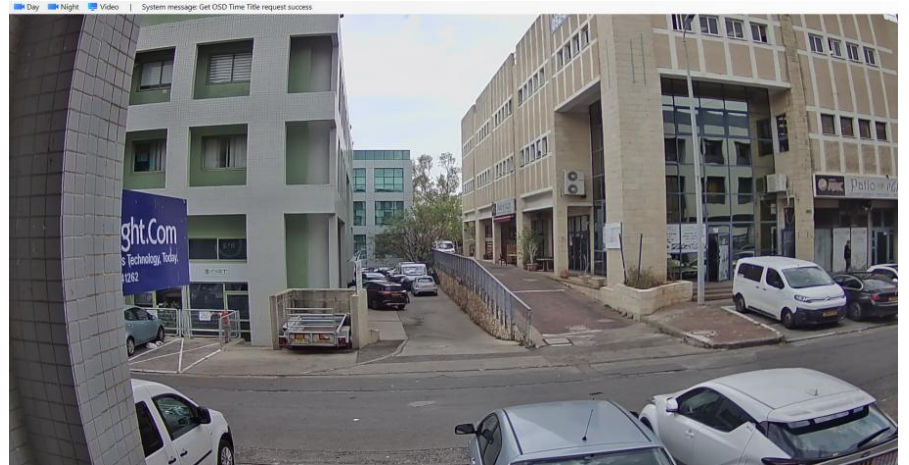

Night

Clicking on Night will cause the application to show only the stream from the night camera on the whole screen: Night



Fusion

Clicking on Fusion will cause the application to show both streams from the day camera and night camera on the whole screen: Fusion



PRODUCT PIN LAYOUT



PANEL Pin Layout D38999/23YC35PN

Stainless Steel Hermetic Connector

CABLE PIN LAYOUT D38999/26KC35SN

Stainless Steel Hermetic Connector

PIN#	DESCRIPTION
1	NC
2	NC
3	(+9 TO +36VDC) INPUT POWER
4	GND INPUT POWER
5	(+9 TO +36VDC) INPUT POWER
6	GND INPUT POWER
7	NC
8	NC
9	ETHERNET2 (1) TX+
10	ETHERNET2 (2) TX-
11	ETHERNET2 (3) RX+
12	ETHERNET2 (6) RX-
13	NC
14	NC
15	ETHERNET1 (1) TX+
16	ETHERNET1 (2) TX-
17	ETHERNET1 (3) RX+
18	ETHERNET1 (6) RX-
19	DAY VIDEO CVBS SIGNAL
20	DAY VIDEO CVBS GND
21	THERMAL VIDEO CVBS SIGNAL
22	THERMAL VIDEO CVBS GND

PIN#	DESCRIPTION
1	NC
2	NC
3	(+9 TO +36VDC) INPUT POWER
4	GND INPUT POWER
5	(+9 TO +36VDC) INPUT POWER
6	GND INPUT POWER
7	NC
8	NC
9	ETHERNET2 (1) TX+
10	ETHERNET2 (2) TX-
11	ETHERNET2 (3) RX+
12	ETHERNET2 (6) RX-
13	NC
14	NC
15	NC
16	NC
17	NC
18	NC
19	NC
20	NC
21	NC
22	NC

Section 5

FUSION-F PRODUCT DATASHEET

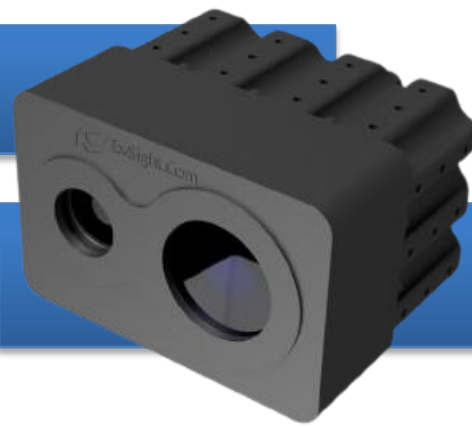

FUSION-F is a powerful pure digital dual sensor vision system for superior situational awareness

Product Highlights

- Embedded network switch
- Sensor daisy chain via Ethernet to save cabling
- Two Analog Out CVBS interfaces – Day + LWIR
- ONVIF Low Light Day Sensor 1080x1920
- ONVIF LWIR 12 μ m Sensor
- Hermetic IP-67, Nitrogen Purged, Military Grade
- Hermetic MIL.STD D38999/23YC35PN Connector
- Black Hard Anodized CNC Aluminum Chassis
- Easy Sensor-To-Screen, Sensor-To-PC Installation
- Optional SD card recording
- 9-36VDC Embedded Power Stabilizer



UNCOOLED LWIR DVE SYSTEM

THERMAL SENSOR

UNCOOLED LWIR 12 μm , RESOLUTION (PIXELS) 640x512/1280x1024, LENS (640) 5.8mm / (1280) 13mm, FOV 67° (69.4° x57.3°) / 61° x50°, PITCH 12 μm , SPECTRAL BAND 8-14 μm / 7.5-13.5 μm , FRAME RATE 50 FPS, SENSITIVITY (NEDT) <50mK at F/1.0, GERMANIUM WINDOW

DAY SENSOR (VIS)

SONY IMX327 1920x1080/2MP FULL HD, H.265/H.264/MJPEG, Video Frame Main stream 1920*1080(30fps), Sub stream: 1280*720/704*576 640*480 352*288(30fps), Video Bit rate 16kbps~20Mbps, CBR/VBR, S/N Ratio $\geq 60\text{dB}$, Min Illumination 0.001Lux@F1.2, Ethernet Interface 1PCS RJ45 10M/100M TCP/IP, UDP, RTP, RTSP, RTCP, RTMP, HTTP, DNS, DDNS, DHCP, NTP, PPPOE, SMTP, UPNP SAPPHIRE WINDOW 3mm

FOV DAY SENSOR

LENS 4mm DC DRIVE M12, FOV (H) 84.6° (V) 45.9° (D) 100.0°

INTERFACES

ANALOG OUT FORMAT: 2 OUTPUTS X PAL (DAY + LWIR), ETHERNET SINGLE CONNECTION, INTERNAL EMBEDDED SWITCH, SDK WEB INTERFACE, VIDEO COMPRESSION RTSP H.264 / H.265 STREAMING, CAMERA CONTROL - SDK (CODE EXAMPLES INCLUDED), VIDEO STREAM : 2 SEPARATE DIGITAL VIDEO CHANNELS FROM EACH CAMERA WITH DIFFERENT SETUPS, HERMETIC D38999/23YC35PN CONNECTOR

PSU (POWER SUPPLY UNIT)

9-36VDC, NOMINAL 5.6W, (MAX on LOAD 12W)

HOUSING

BLACK HARD ANODIZED ALUMINUM, STAINLESS STEEL N316 SCREWS, NITROGEN VALVE IN, SEALED OUTPUT SCREW, IP-67, NITROGEN PURGED, "O" RINGS

ENVIRONMENTAL

OPERATING TEMP -20°C to +80°C

DIMENSIONS

(LxWxH, mm) 147x119x96mm, WEIGHT 2,300 gm

FUSION-F640 DRI LWIR (m)

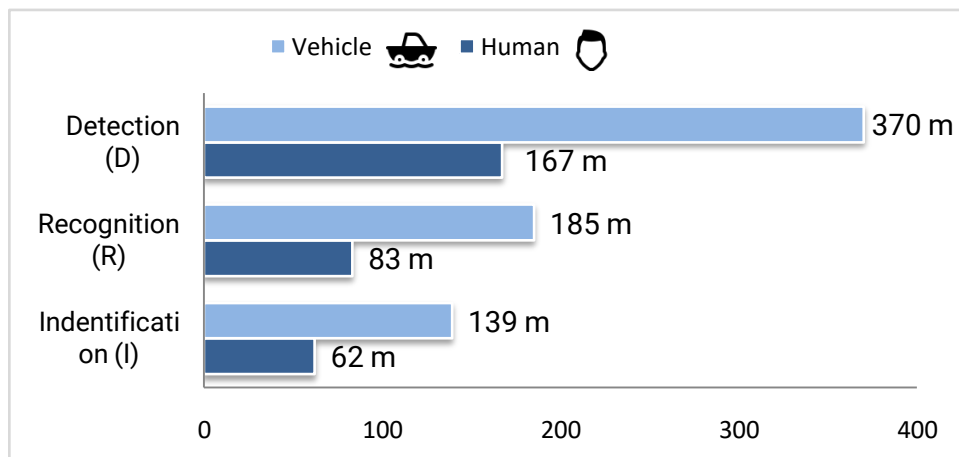

FUSION-F1280 DRI LWIR (m)

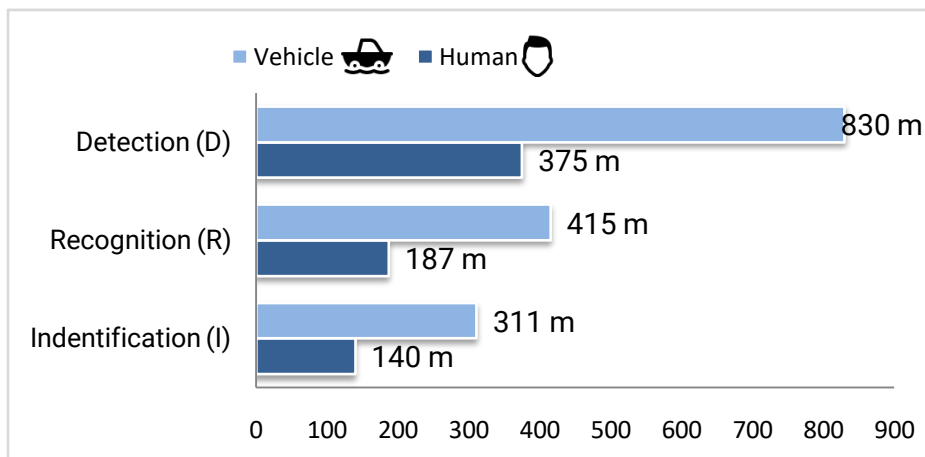

Calculation according to Johnson Criteria

DIMENSIONS (mm)

FUSION-F PART NUMBERING:

FUSION-F[RES]-[FOV]-[POS]

[RES] LWIR RESOLUTION

640 (LWIR 640x512 , 5.8mm)

1280 (LWIR 1280x1024 , 13mm)

[FOV] FIELD OF VIEW

70 (69.4° x 57.3°)

S – Synchronized FOV, LWIR & DAY FOV are similar

[POS] POSITION

H (HORIZONTAL)

V (VERTICAL)

SENSOR POSITIONING

HORIZONTAL



VERTICAL

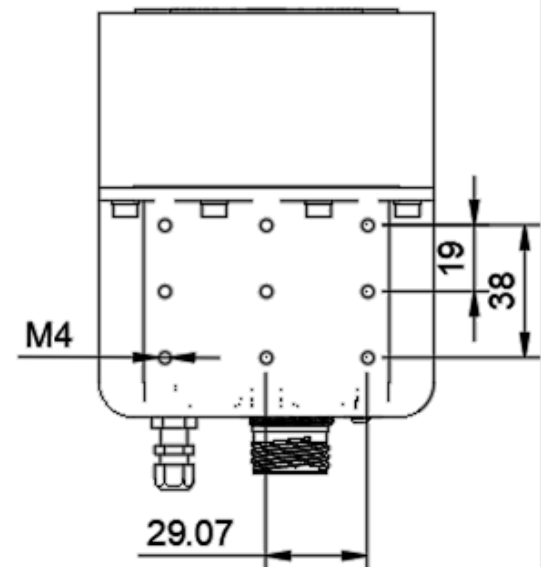
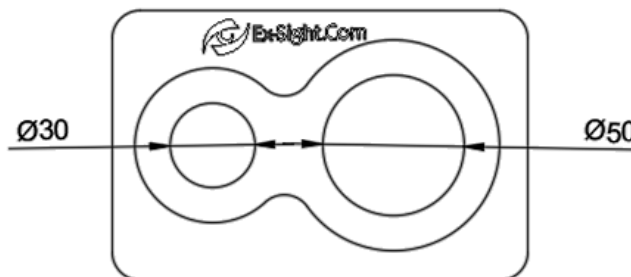
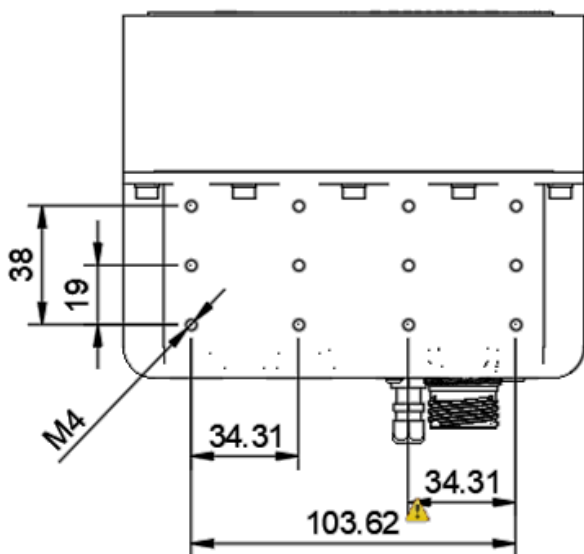
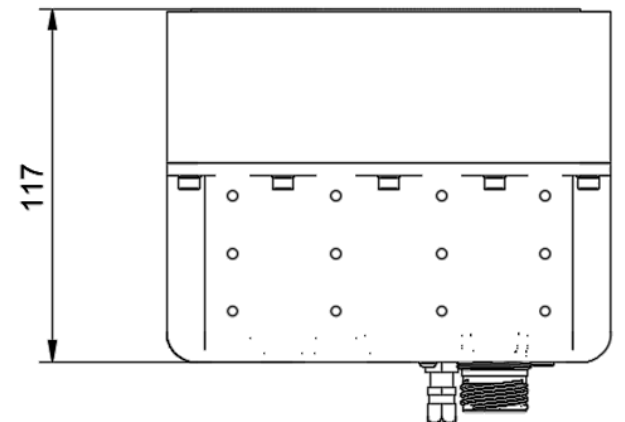
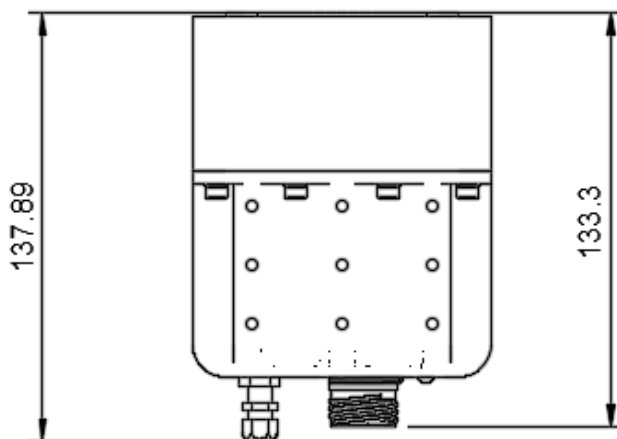
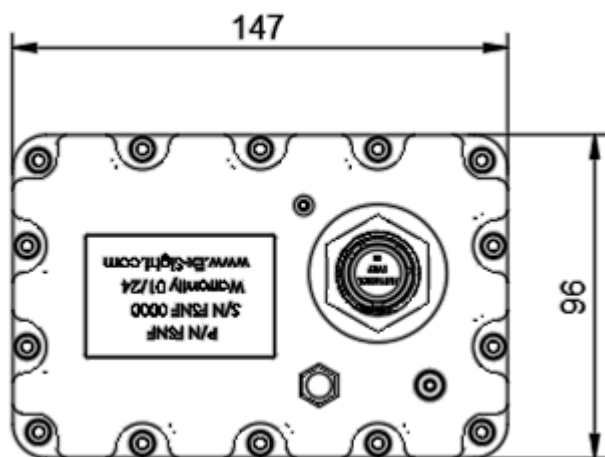

PRODUCT PIN LAYOUT

PANEL PIN LAYOUT D38999/23YC35PN

Stainless Steel Hermetic Connector



PART Numbering Index

PIN#	DESCRIPTION
1	NC
2	NC
3	(+9 TO +36VDC) INPUT POWER
4	GND INPUT POWER
5	(+9 TO +36VDC) INPUT POWER
6	GND INPUT POWER
7	NC
8	NC
9	ETHERNET2 (1) TX+
10	ETHERNET2 (2) TX-
11	ETHERNET2 (3) RX+
12	ETHERNET2 (6) RX-
13	NC
14	NC
15	ETHERNET1 (1) TX+
16	ETHERNET1 (2) TX-
17	ETHERNET1 (3) RX+
18	ETHERNET1 (6) RX-
19	DAY VIDEO CVBS SIGNAL
20	DAY VIDEO CVBS GND
21	THERMAL VIDEO CVBS SIGNAL
22	THERMAL VIDEO CVBS GND

#	P/N	DESCRIPTION
1	D38999/23YC35PN	Mil. Std Stainless Steel connector
2	MS51377-2 MS51607-1 MS20813-1	Nitrogen Valve Core Nitrogen MS Valves Nitrogen Fitting



CABLE PART NUMBERING

SC CABLE

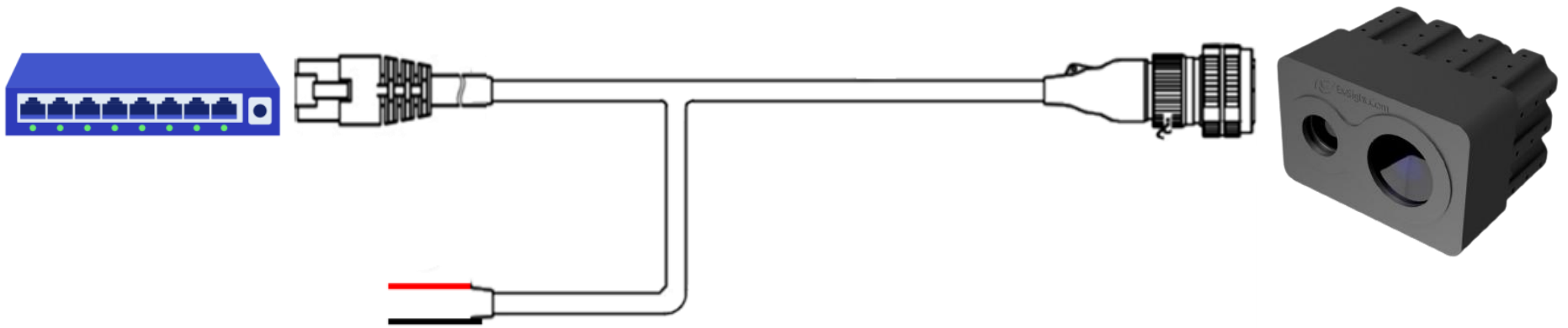

CC CABLE

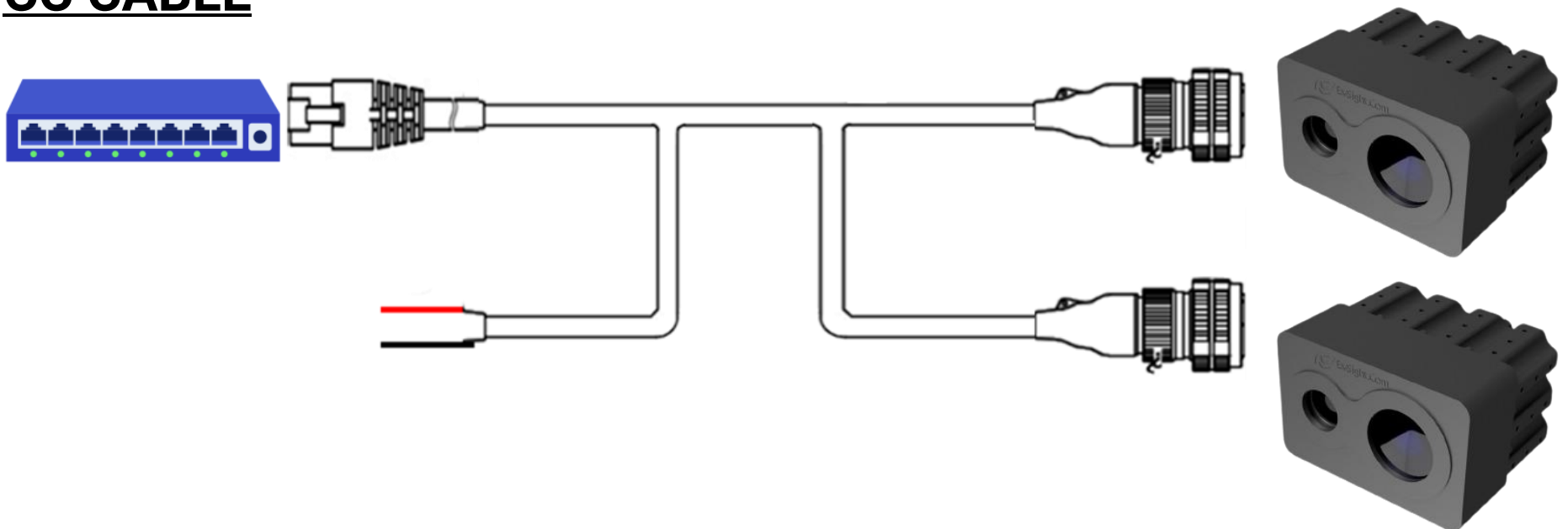

CABLE PART NUMBERING:

FUSION-F-CABLE-[CT]-[LEN1]-[LEN2]

[CT] CABLE TYPE:

SC (SINGLE CABLE)

CC (CHAINED CABLE)

[LEN1] CABLE LENGTH in Meters

[LEN2] CHAINED CABLE LENGTH in Meters (CC cable only)

RQT1601875 CABLE

CABLE SPECIFICATION

22 Conductor Cable

Components:

Cat. 5e Cable:

Conductor: 24 AWG 7/32 Tinned Copper.

Insulation: XLPE, OD 1.3mm.

Color Code: Blue X White, Orange X White, Green X White, Brown X White.

Shield: Aluminum foil + Tinned cooper braid 80% Min coverage.

Jacket: PTX, OD 7.6 mm, Black, Numbered 1-2.

20 AWG pairs:

Conductor: 20 AWG 19/32 Tinned Copper.

Insulation: ETFE, OD 1.4 mm.

Color Code: Black, Red.

Cable:

Two (2) Cat. 5e 4X2X24 AWG SF/UTP.

Three (3) 20 AWG unshielded twisted pairs.

Jacket:

Halogen-free, flame retardant, Cross Linked Thermoplastic Elastomer.
to 17.5 mm nom – Black

Marking:

Jacket marked 'RQT1601875 – Week & Year of Manufacture' at 1000mm intervals.

Performance:

Min. Bend Radius:	180 mm
Min. Band Radius for Operation:	150°mm
Max. Operation Temperature:	+90 C
Min. Operation Temperature:	- 40 C
UV Resistance:	Yes
Weight:	260 Kg/Km

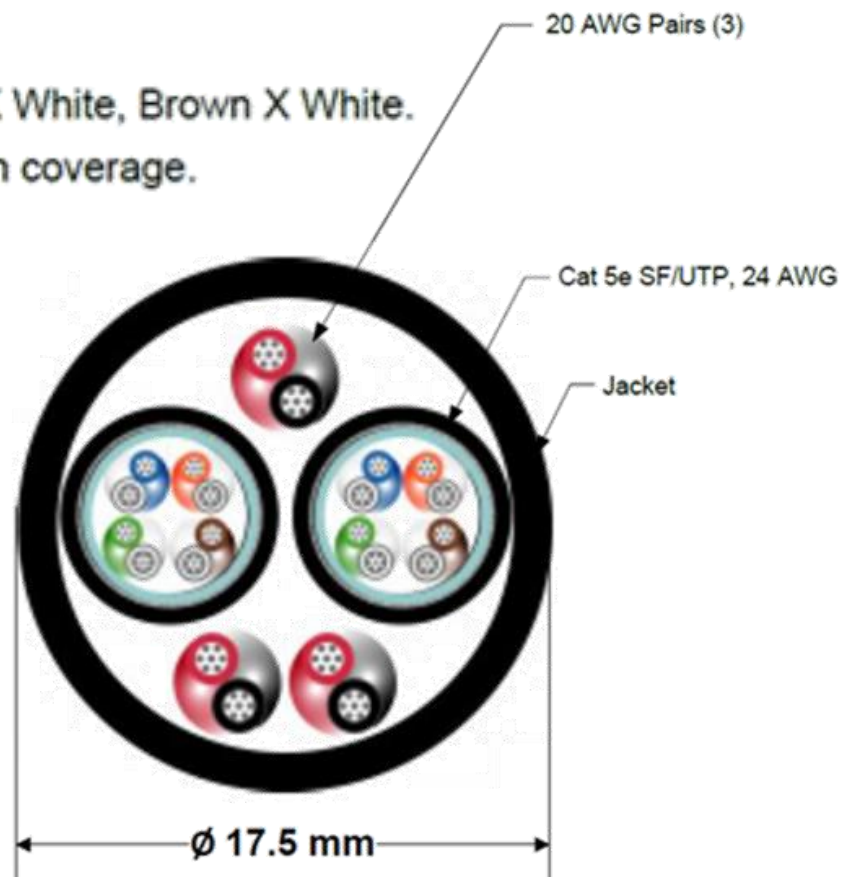

CABLE PIN LAYOUT

CABLE PIN LAYOUT

D38999/26KC35SN

Stainless Steel Hermetic Connector

PIN	DESCRIPTION
1	NC
2	NC
3	(+9 TO +36VDC) INPUT POWER
4	GND INPUT POWER
5	(+9 TO +36VDC) INPUT POWER
6	GND INPUT POWER
7	NC
8	NC
9	ETHERNET2 (1) TX+
10	ETHERNET2 (2) TX-
11	ETHERNET2 (3) RX+

PIN	DESCRIPTION
12	ETHERNET2 (6) RX-
13	NC
14	NC
15	NC
16	NC
17	NC
18	NC
19	NC
20	NC
21	NC
22	NC

FUSION-F-CABLE-SC-[LEN1]

FUSION-F-CABLE is RQT1601875 Cable (6*20AWG + SPEC 55) with specified length.

The cable includes connector D38999/26KC35SN Mil. Std Stainless Steel that connects to the connector D38999/23YC35PN on the FUSION-F.

On the other side of the cable there is a connection to Power 9-36V (open black wire + open red wire) and RJ45 Giga Ethernet connection

MECHANICAL DRAWING

CABLE PART NUMBERING INDEX

#	P/N	DESCRIPTION
1	[LEN1]	Total Cable length (meters)
2	D38999/26KC35SN	Mil. Std Stainless Steel connector (200°C, firewall capability, 500 hour salt spray resistance)
3	RQND-40S2-S-1307	Stainless Steel Backshell
4	202K121-25-0	Boot
5	Cable RQT1601875	6*20AWG + SPEC55 (RAYCHEM DR-25)
6	Cable RQT1601875	6*20AWG + SPEC55 (1m) (RAYCHEM DR-25)
7	RJ45 Ethernet	Main Ethernet connector
8	Power Wires	20AWG For 9V-36V input

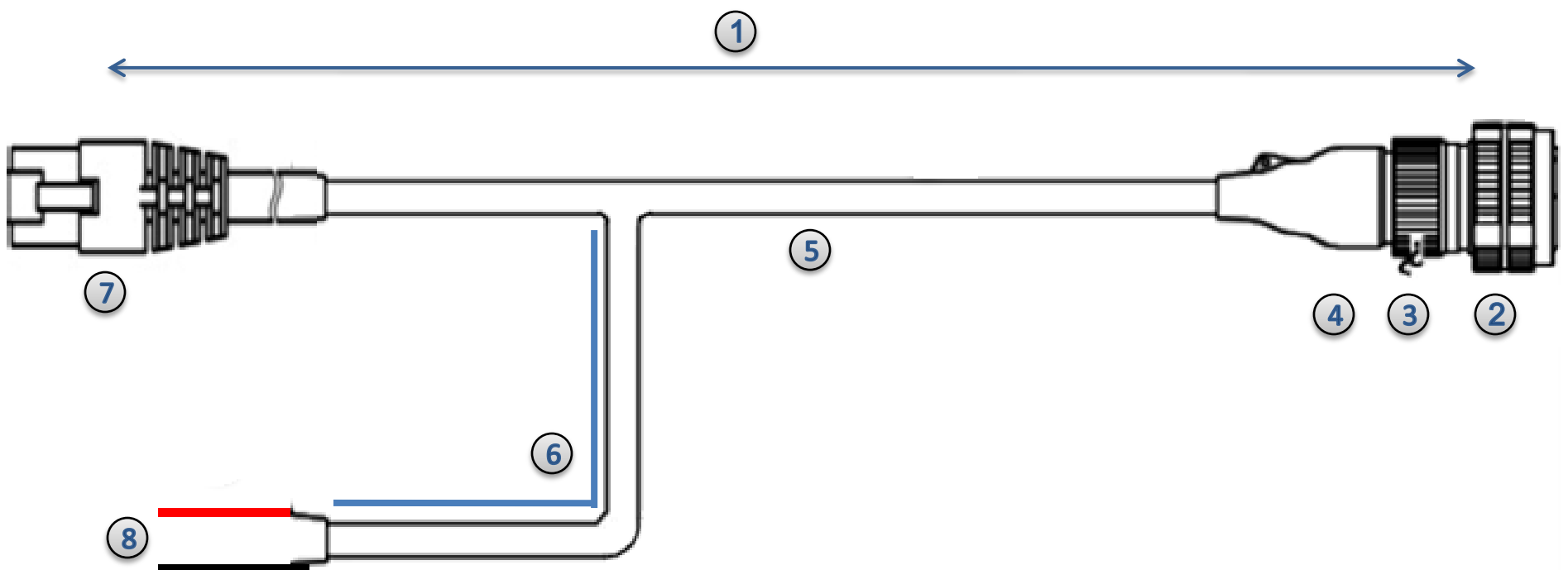

CABLE PIN LAYOUT

CABLE PIN LAYOUT

D38999/26KC35SN

Stainless Steel Hermetic Connector

PIN	DESCRIPTION
1	NC
2	NC
3	(+9 TO +36VDC) INPUT POWER
4	GND INPUT POWER
5	(+9 TO +36VDC) INPUT POWER
6	GND INPUT POWER
7	NC
8	NC
9	ETHERNET2 (1) TX+
10	ETHERNET2 (2) TX-
11	ETHERNET2 (3) RX+

PIN	DESCRIPTION
12	ETHERNET2 (6) RX-
13	NC
14	NC
15	NC
16	NC
17	NC
18	NC
19	NC
20	NC
21	NC
22	NC

FUSION-F-CABLE-CC-[LEN1]-[LEN2]

FUSION-F-CABLE is RQT1601875 Cable (6*20AWG + SPEC 55) with specified length and Additional Chained sensor connector.

The cable includes two connectors D38999/26KC35SN Mil. Std Stainless Steel that connects to the connectors

D38999/23YC35PN on the two FUSION-F.

On the other side of the cable there is a connection to Power 9-36V (open black wire + open red wire) and RJ45 Giga Ethernet connection.

MECHANICAL DRAWING

CABLE PART NUMBERING INDEX

#	P/N	DESCRIPTION
1	[LEN1]	Total Cable length (meters)
2	D38999/26KC35SN	Mil. Std Stainless Steel connector (200°C, firewall capability, 500 hour salt spray resistance)
3	RQND-40S2-S-1307	Stainless Steel Backshell
4	202K121-25-0	Boot
5	[LEN2]	Chained Cable Length (meter) from split
6	Cable RQT1601875	6*20AWG + SPEC55 (RAYCHEM DR-25)
7	Cable RQT1601875	6*20AWG + SPEC55 (1m) (RAYCHEM DR-25)
8	RJ45 Ethernet	Main Ethernet connector
9	Power Wires	20AWG For 9V-36V input

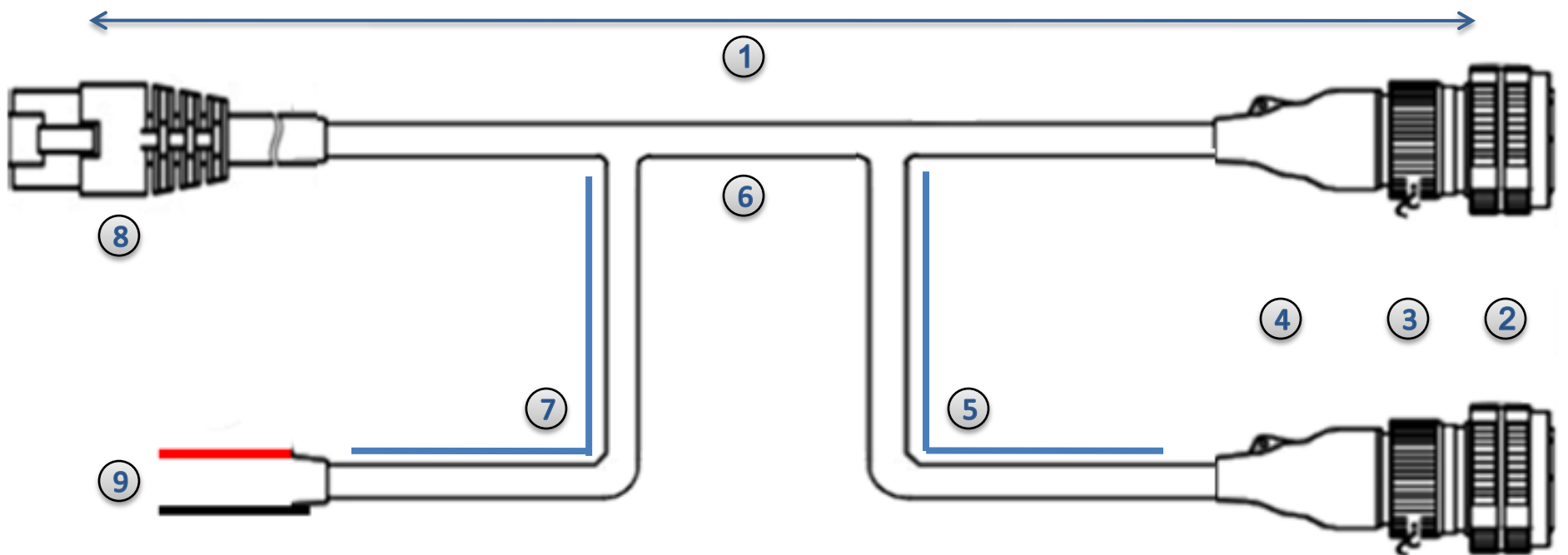

INSTALLATION

FUSION-F-BRKT-01

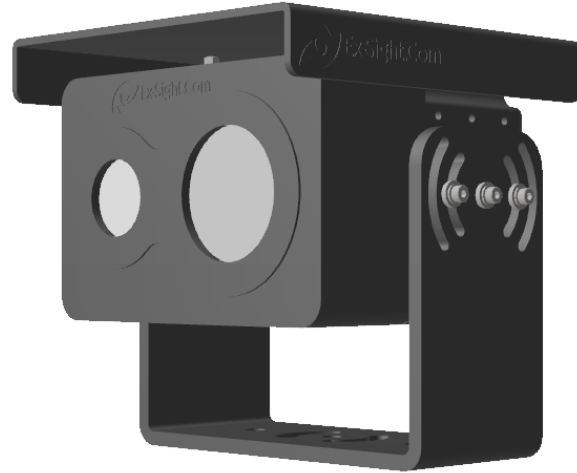
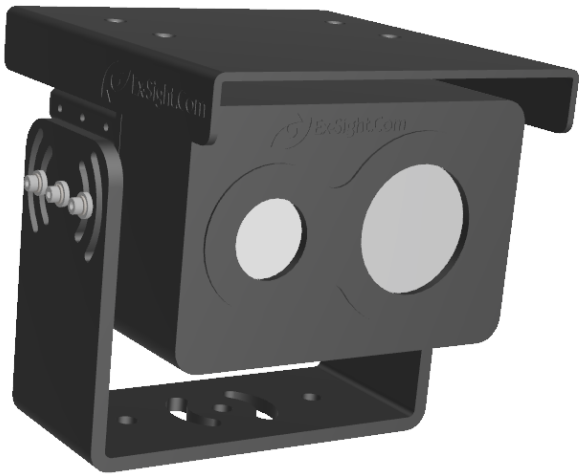

FUSION-F-BRKT-01

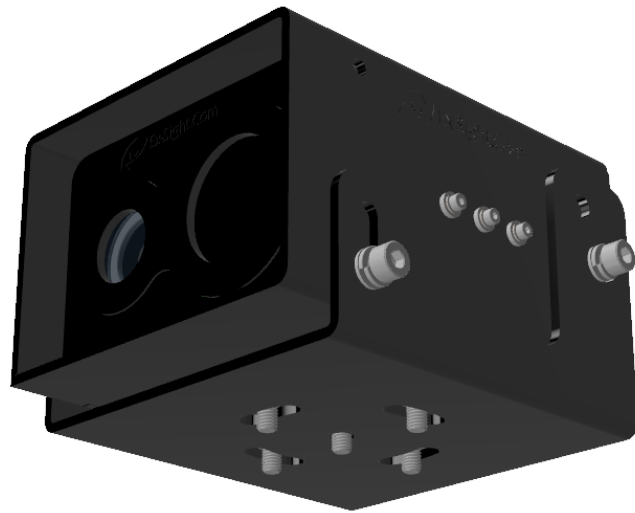

BRACKET PART NUMBERING:

FUSION-F-BRKT-[BT]

[BT] BRACKET TYPE:

01 ANODIZED ALUMINUM LIGHT BRACKET

02 BLACK STEEL BRACKET

INSTALLATION

POSSIBLE INSTALLATION ANGLES

0°

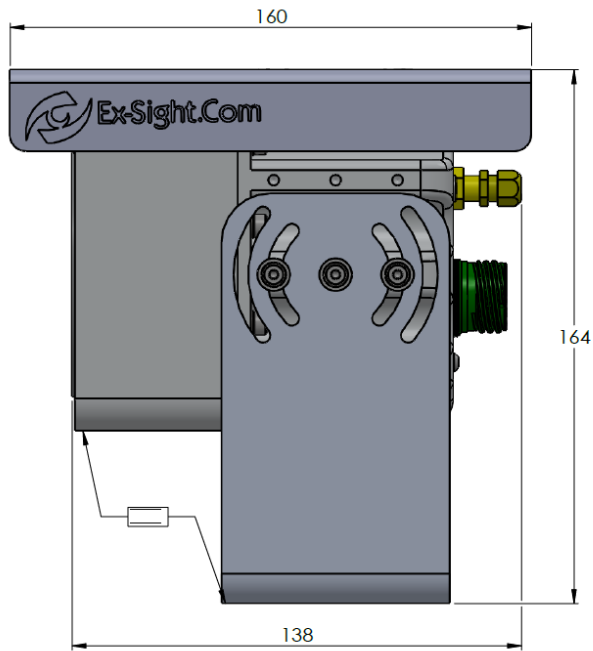

45°

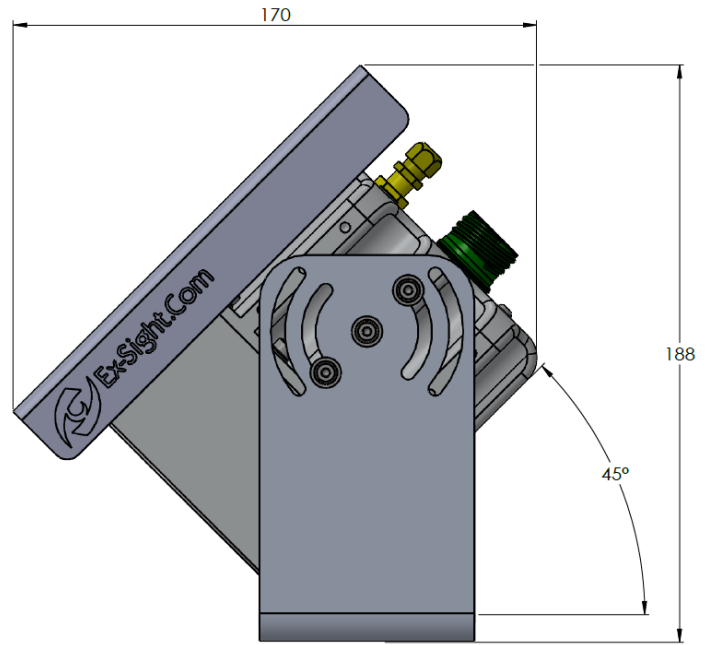

50°

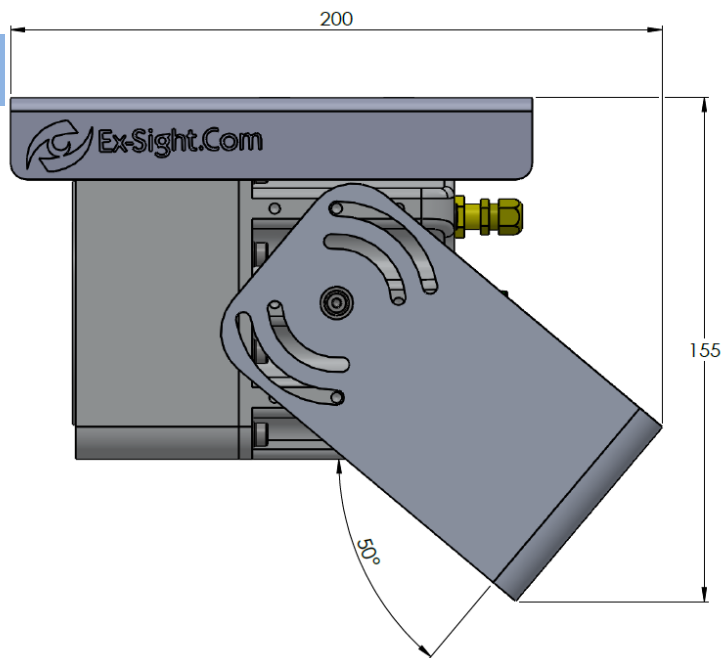

90°

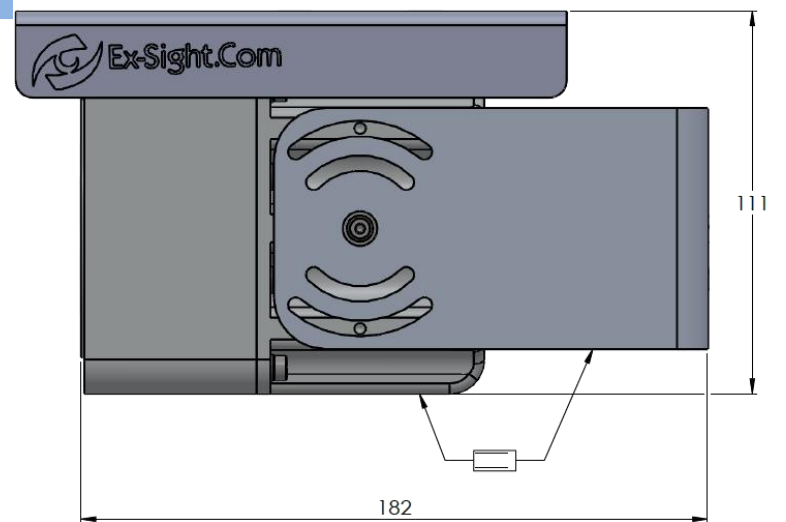

130°

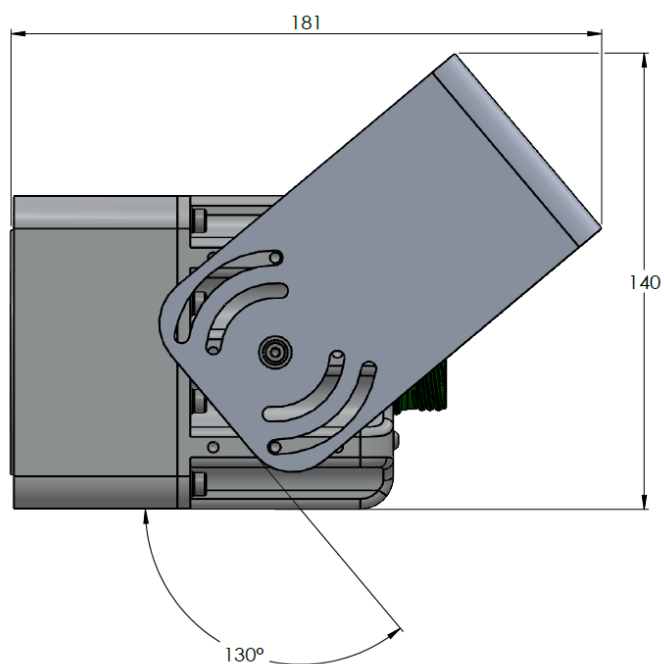

135°

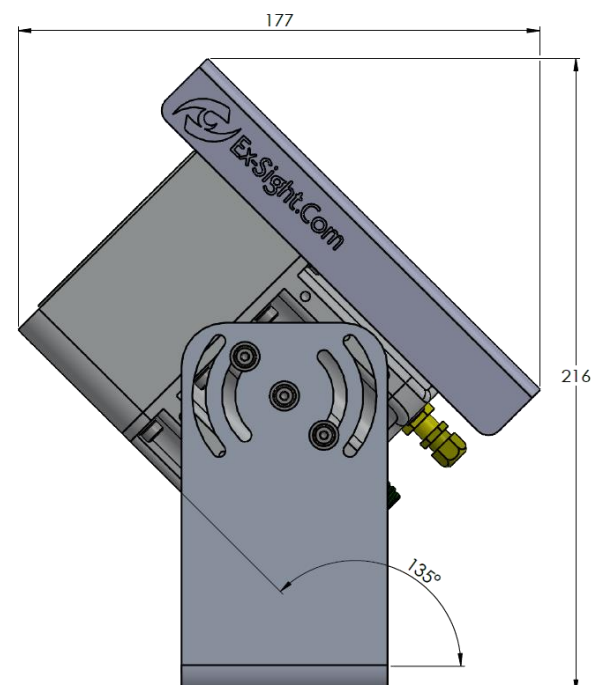

INSTALLATION

INSTALLATION ANGLES LIMITATIONS

-15°

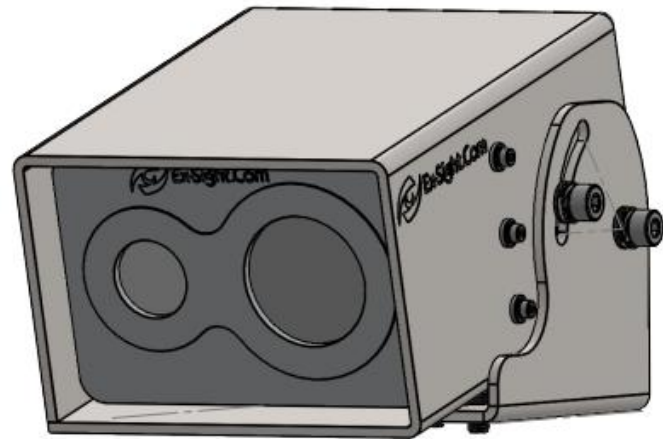
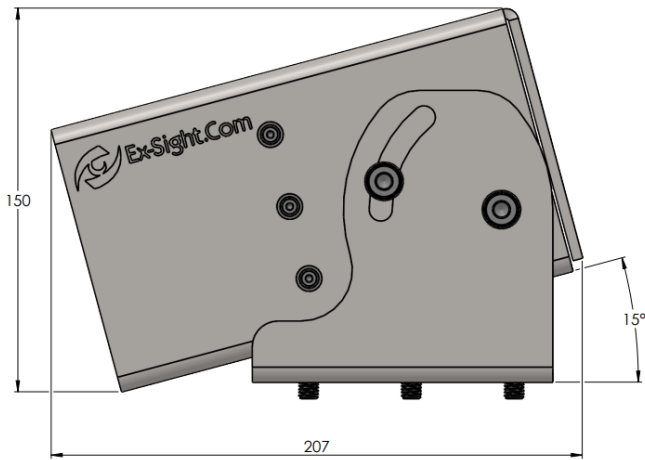

0°

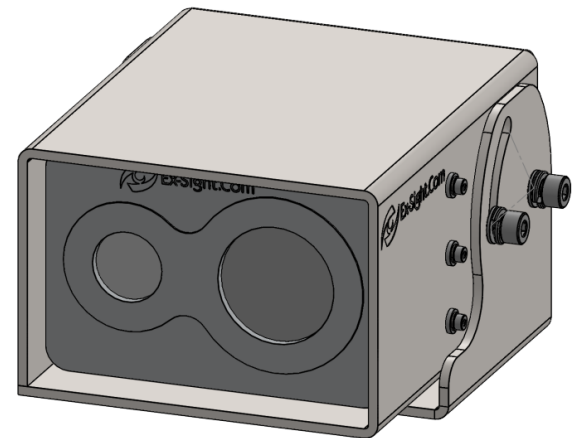
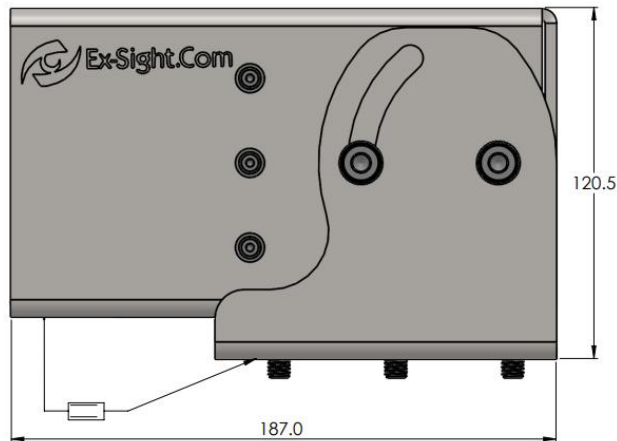
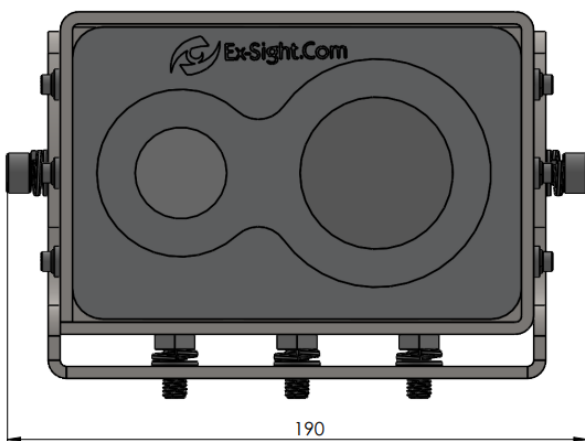

50°

